

MİMARİ KATALOG  
ARCHITECTURAL CATALOGUE

Alüminyum Kapı Pencere ve Giydirme Cephe Sistemleri  
Aluminium Window Doors and Facade Systems

**RESCARA**

# RPE82

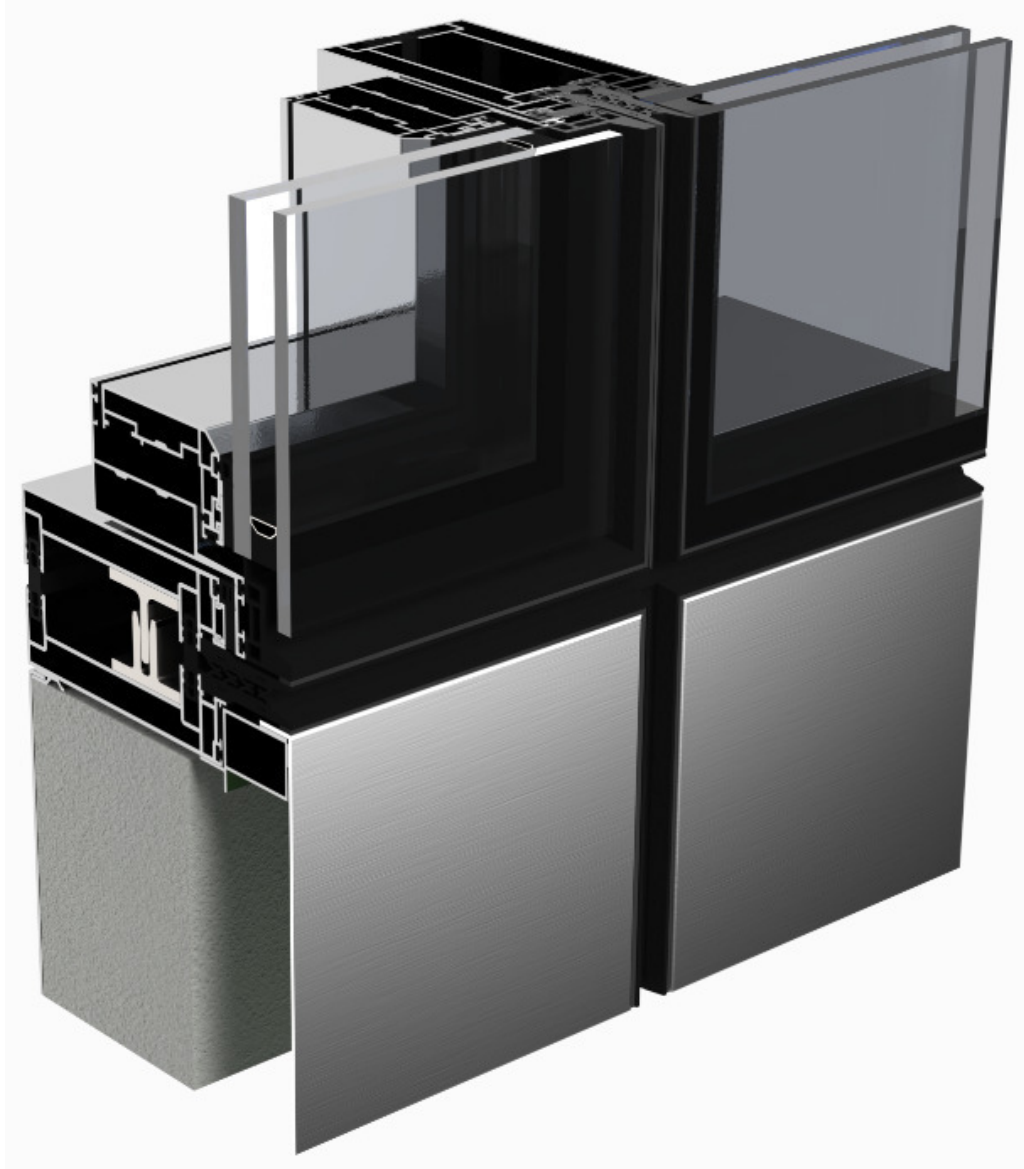

KOD/ CODE	AĞIRLIK (kg/m)/ WEIGHT	Jxx cm <sup>4</sup>	Jyy cm <sup>4</sup>	Wx cm <sup>3</sup>	Wy cm <sup>3</sup>	L m
RPE82 M 01	2,249	8,712	174,704			6
RPE82 M 03	2,822	27,822	284,126			6

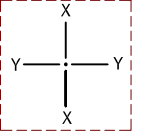

RPE82 M 01

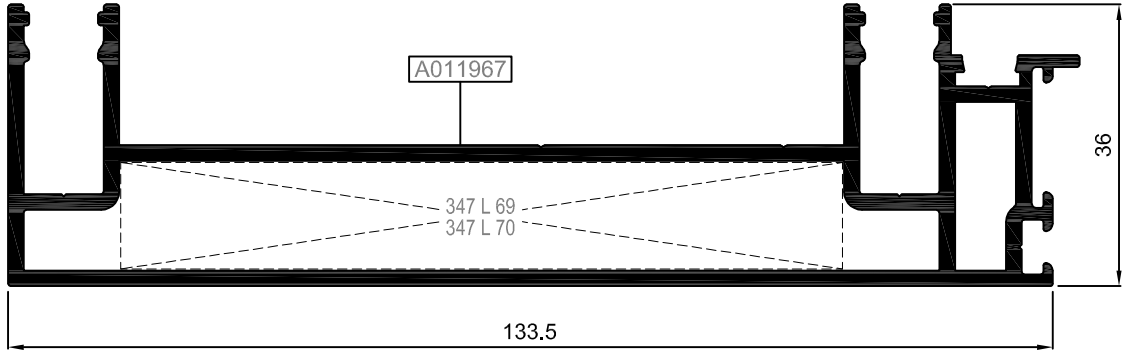

RPE82 M 03

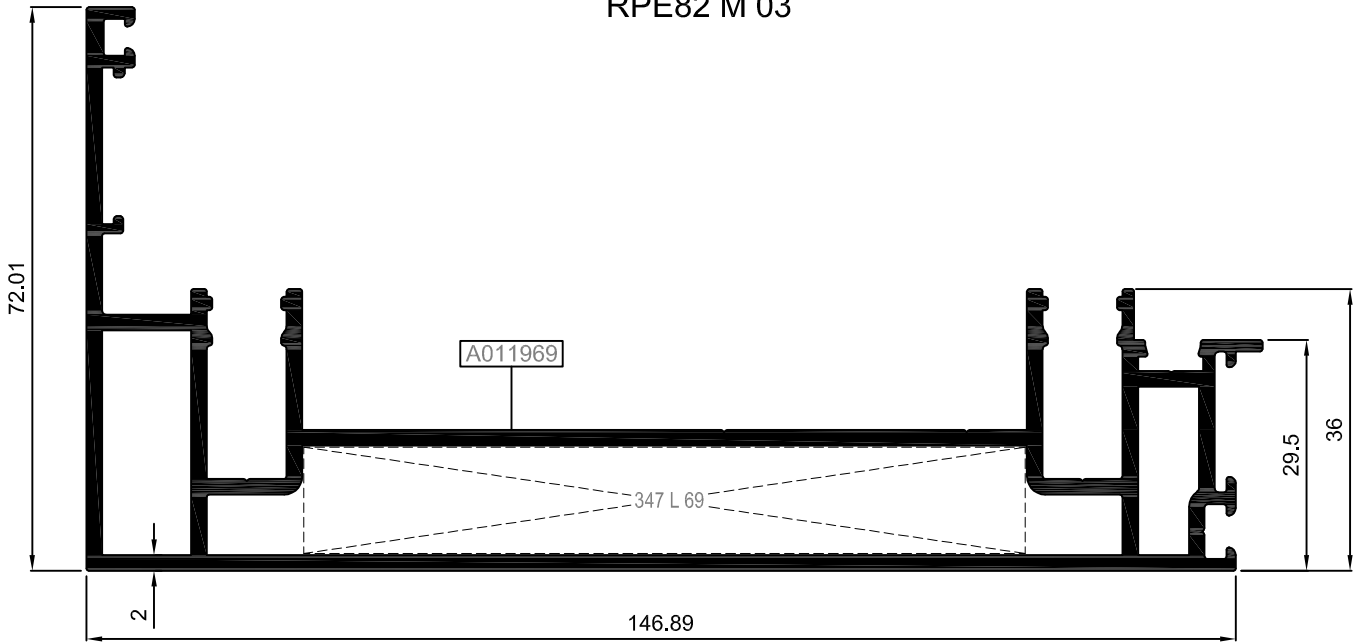

Nr	KÖŞE BAĞLANTI PROFİLİ		KESİM ÖLÇÜSÜ
	PROFİL KOD NUMARASI	PARÇA KOD NUMARASI	
RPE82 M 01	A011967	A011097 (25 L 69)	92,2 mm
		A011105 (25 L 70)	92,2 mm
RPE82 M 03	A011969	A011097 (25 L 69)	92,2 mm

ORTA KAYIT PROFİLLERİ  
MULLION PROFILES

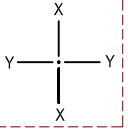

# RPE82

KOD/ CODE	AĞIRLIK (kg/m)/ WEIGHT	Jxx cm <sup>4</sup>	Jyy cm <sup>4</sup>	Wx cm <sup>3</sup>	Wy cm <sup>3</sup>	L m
RPE82 M 02	3,085	126,792	287,419			6

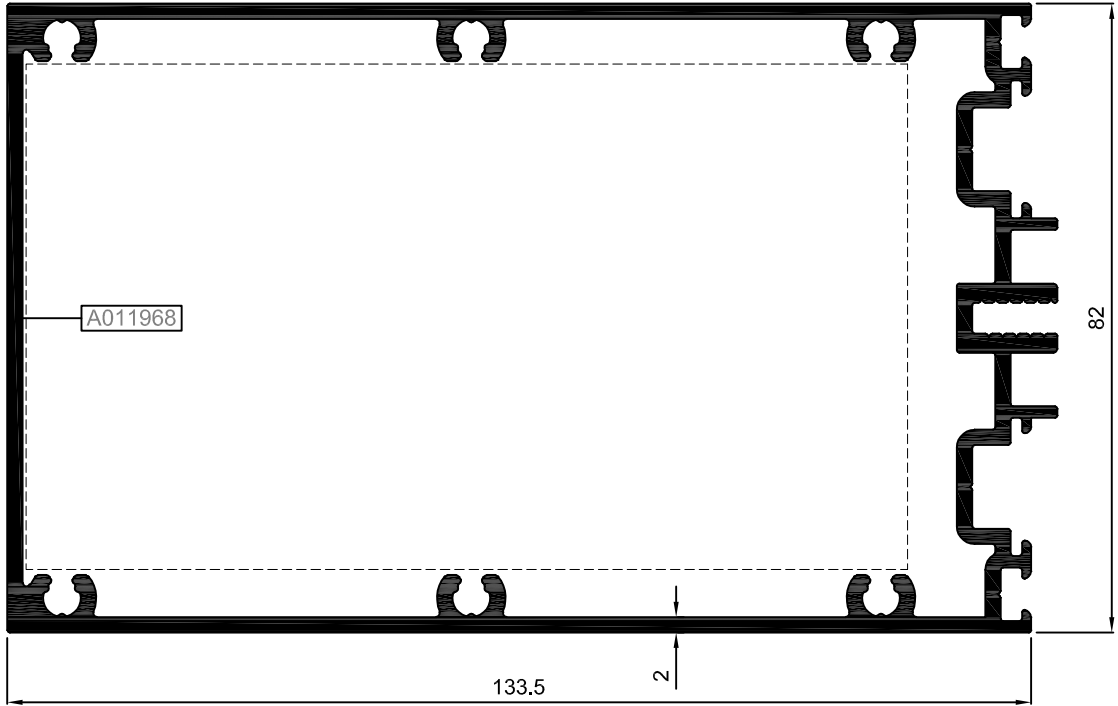

## RPE82 M 02



Nr	DÜŞEY BAĞLANTI PROFİLİ / MULLION CONNECTION PROFILE				KESİM ÖLÇÜSÜ CUTTING SIZE	
	PROFİL KODU / PROFILE CODE		AKSESUAR KODU / ACCESSORY CODE			
RPE82 M 02	A011968	A011975		06.03.01		121,1 mm

KOD/ CODE	AĞIRLIK (kg/m)/ WEIGHT	Jxx cm4	Jyy cm4	Wx cm3	Wy cm3	L m
RPE82 V 01	0,627	2,826	3,372			6
RPE82 V 02	0,775	4,782	3,221			6
RPE82 V 03	0,725	3,642	7,271			6

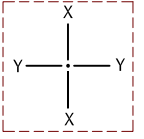

RPE82 V 01

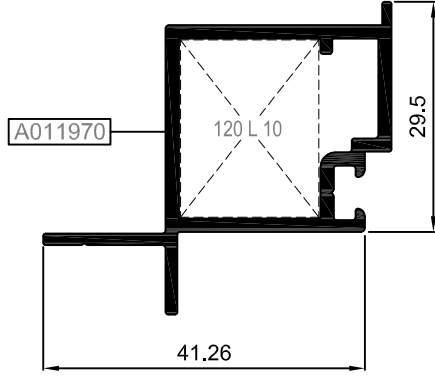

RPE82 V 02

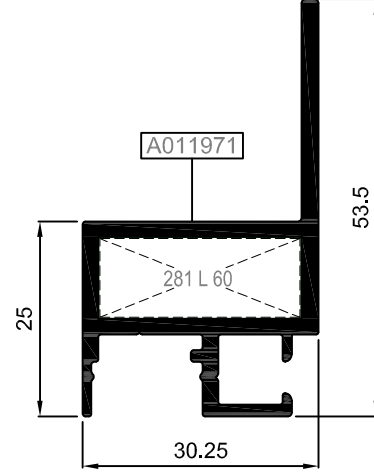

RPE82 V 03

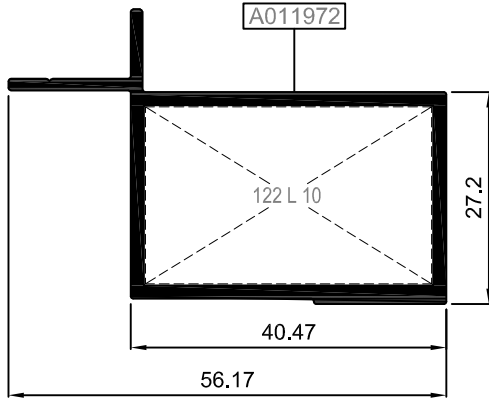

Nr	KÖŞE BAĞLANTI PROFİLİ PROFİL KOD NUMARASI	KÖŞE BAĞLANTI PROFİLİ PARÇA KOD NUMARASI	KESİM ÖLÇÜSÜ
RPE82 V 01	A011970 A002125 (25 L 10)	120 L 10	17,7 mm
RPE82 V 02	A011971 A010546 (25 L 60)	281 L 60	25,7 mm
RPE82 V 03	A011972 A002125 (25 L 10)	122 L 10	36,7 mm

KASA VE BAĞLANTI PROFİLLER  
FRAME AND CONNECTION PROFILES

RPE82

KOD/ CODE	AĞIRLIK (kg/m)/ WEIGHT	Jxx cm4	Jyy cm4	Wx cm3	Wy cm3	L m
RPE82 H 01	1,540	20,767	70,433			6
RPE82 C 01	2,379	50,834	25,058			6

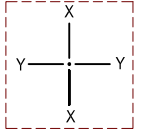

RPE82 H 01

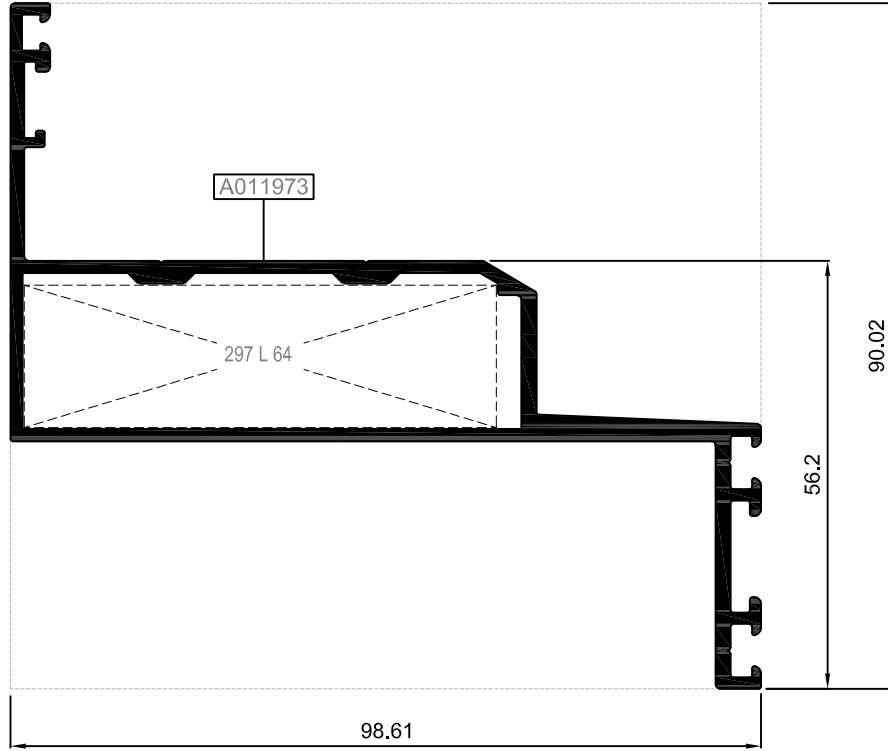

RPE82 C 01

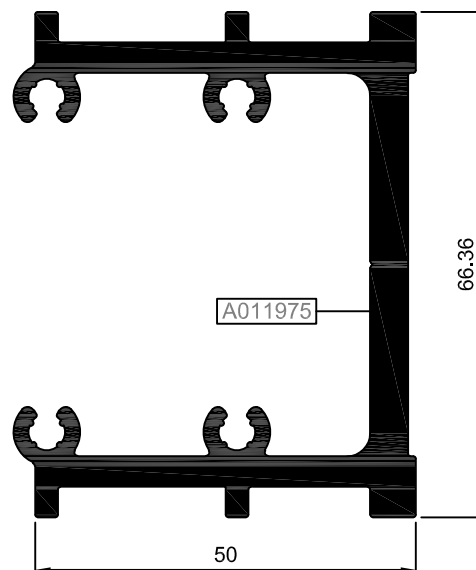

Nr	KÖŞE BAĞLANTI PROFİLİ		KÖŞE BAĞLANTI PROFİLİ		KESİM ÖLÇÜSÜ
	PROFİL KOD NUMARASI		PARÇA KOD NUMARASI		
RPE82 H 01	A011973	A010028 (25 L 64)	297 L 64		62,1 mm

KOD/ CODE	AĞIRLIK (kg/m)/ WEIGHT	Jxx cm <sup>4</sup>	Jyy cm <sup>4</sup>	Wx cm <sup>3</sup>	Wy cm <sup>3</sup>	L m
RPE82 A 01	0,113	0,013	0,160			6
RPE82 A 02	0,240	0,493	1,208			6
RPE82 A 03	0,117	0,300	0,001			6
RPE82 A 04	0,172	0,308	0,046			6
RPE82 S 01	1,154	2,191	6,586			6

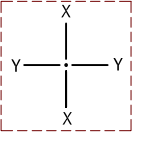

RPE82 A 01

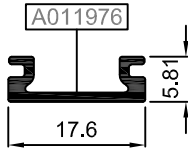

RPE82 A 02

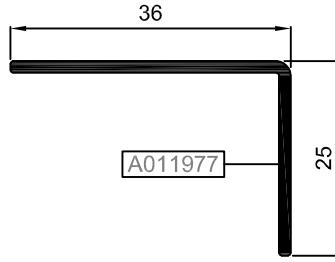

RPE82 A 03

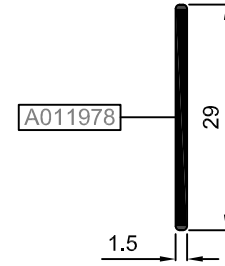

RPE82 A 04

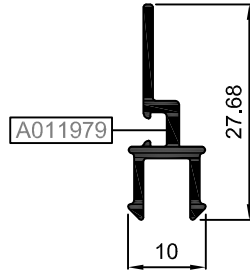

RPE82 S 01

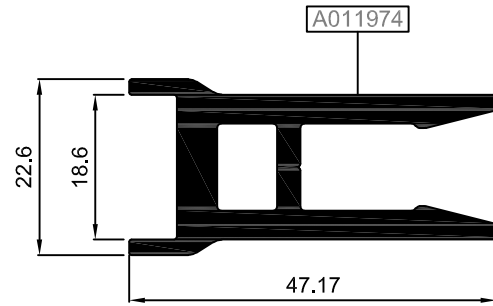

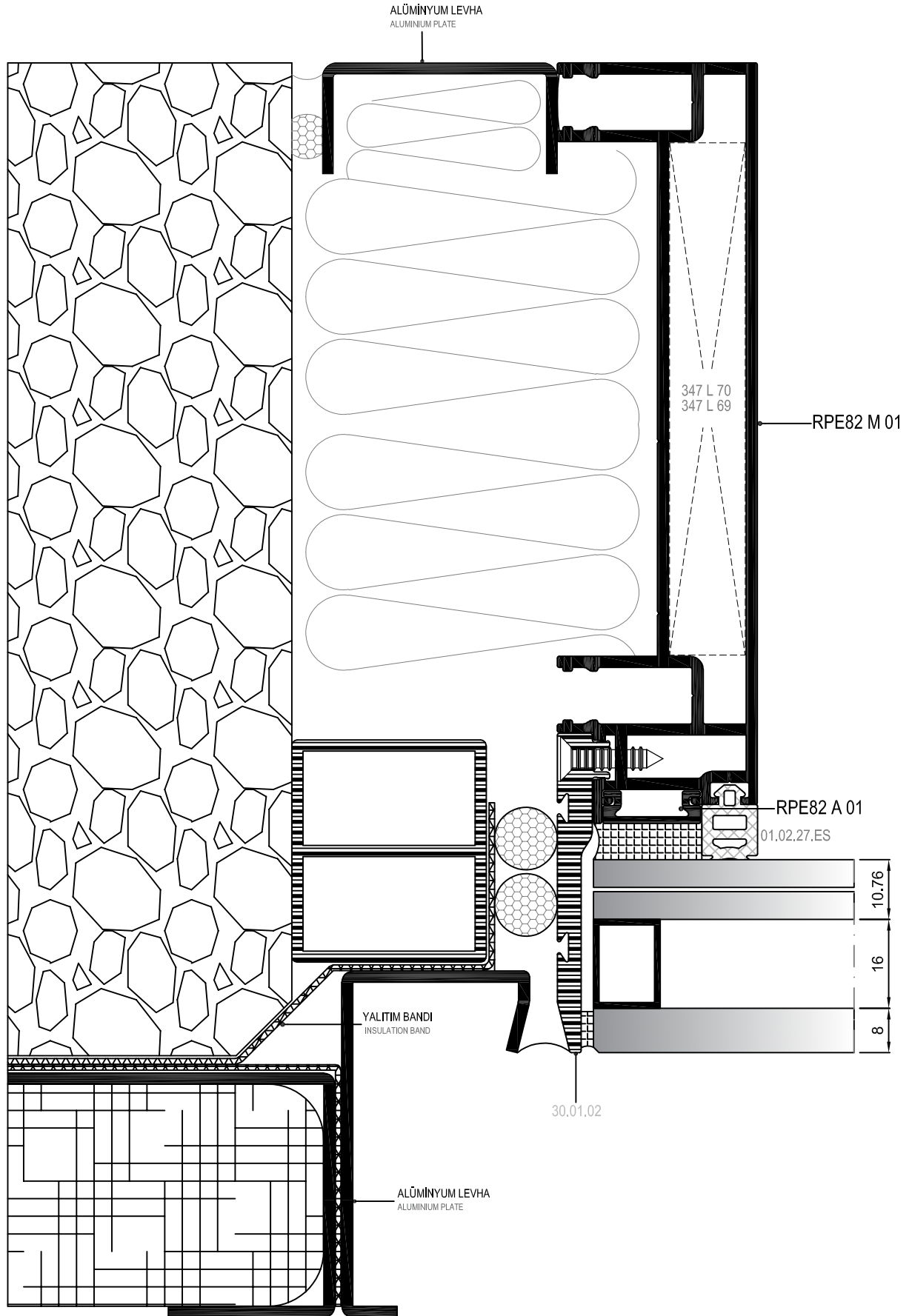

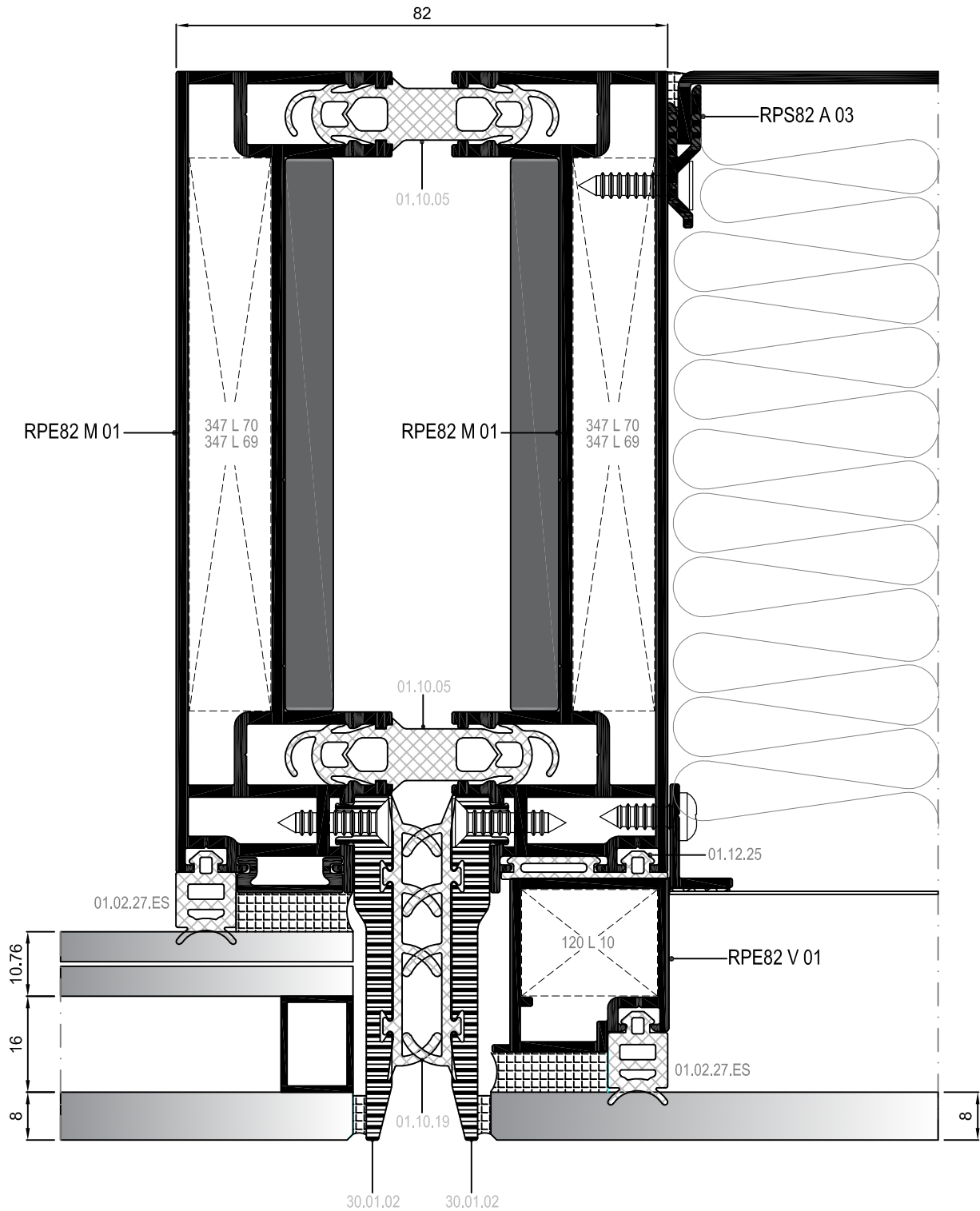



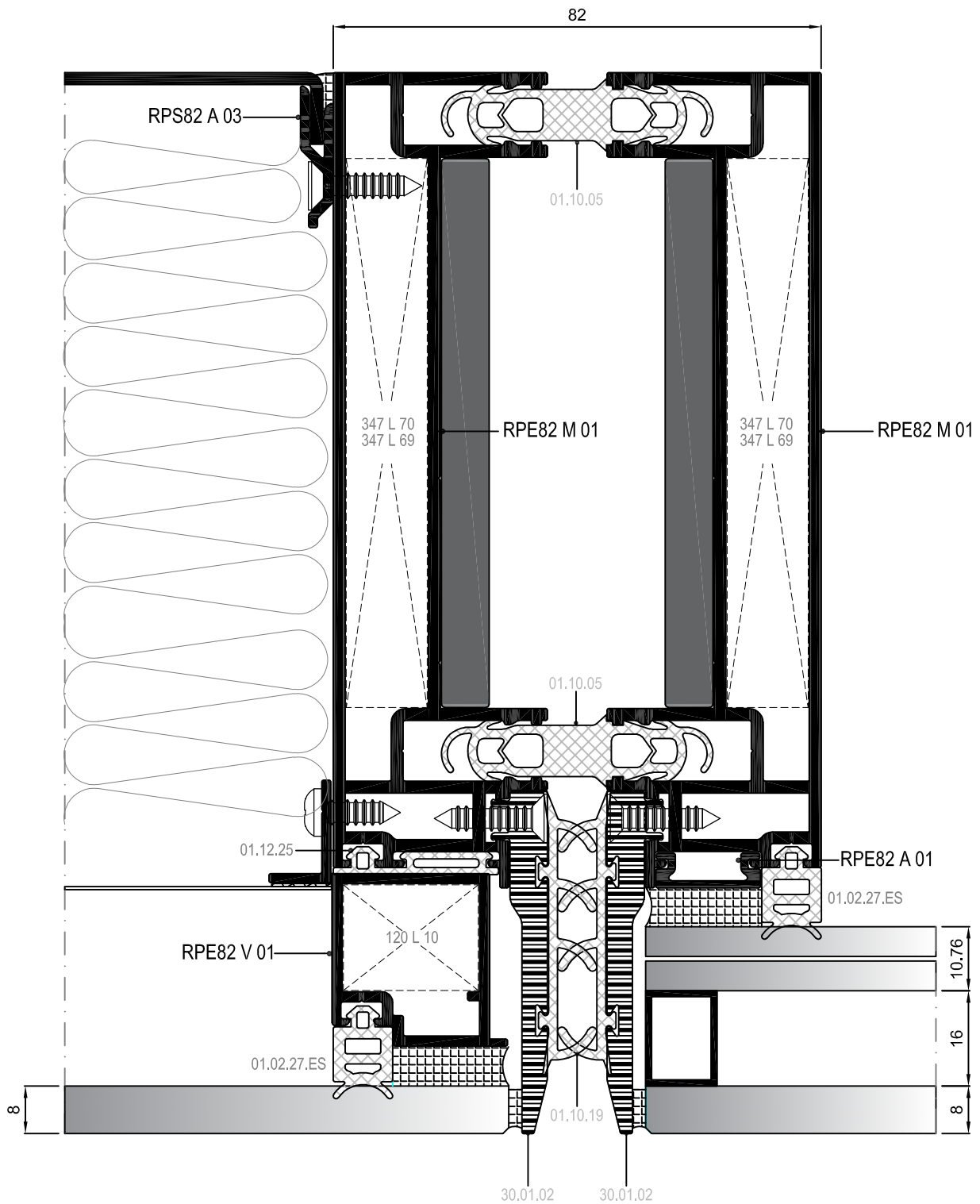

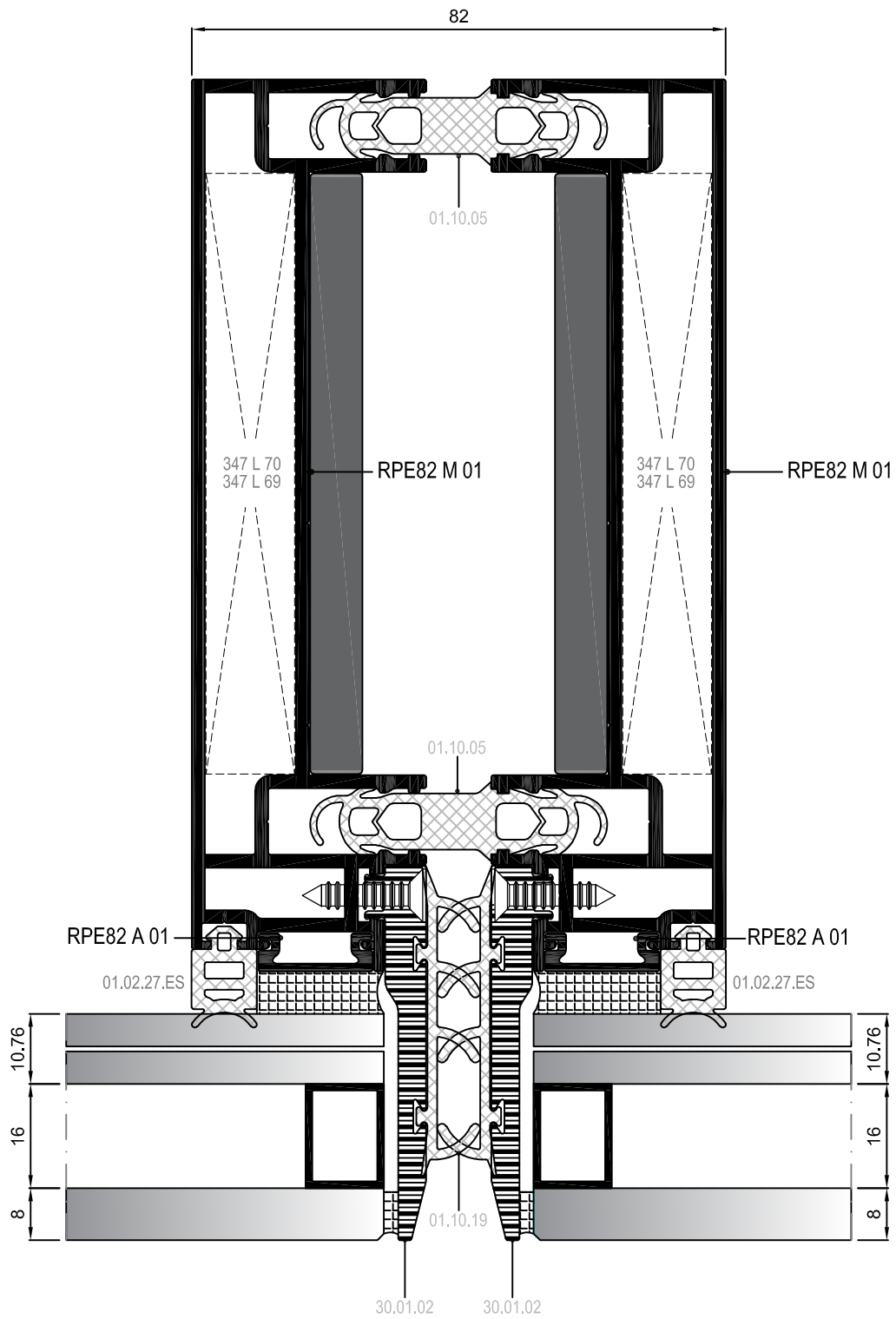

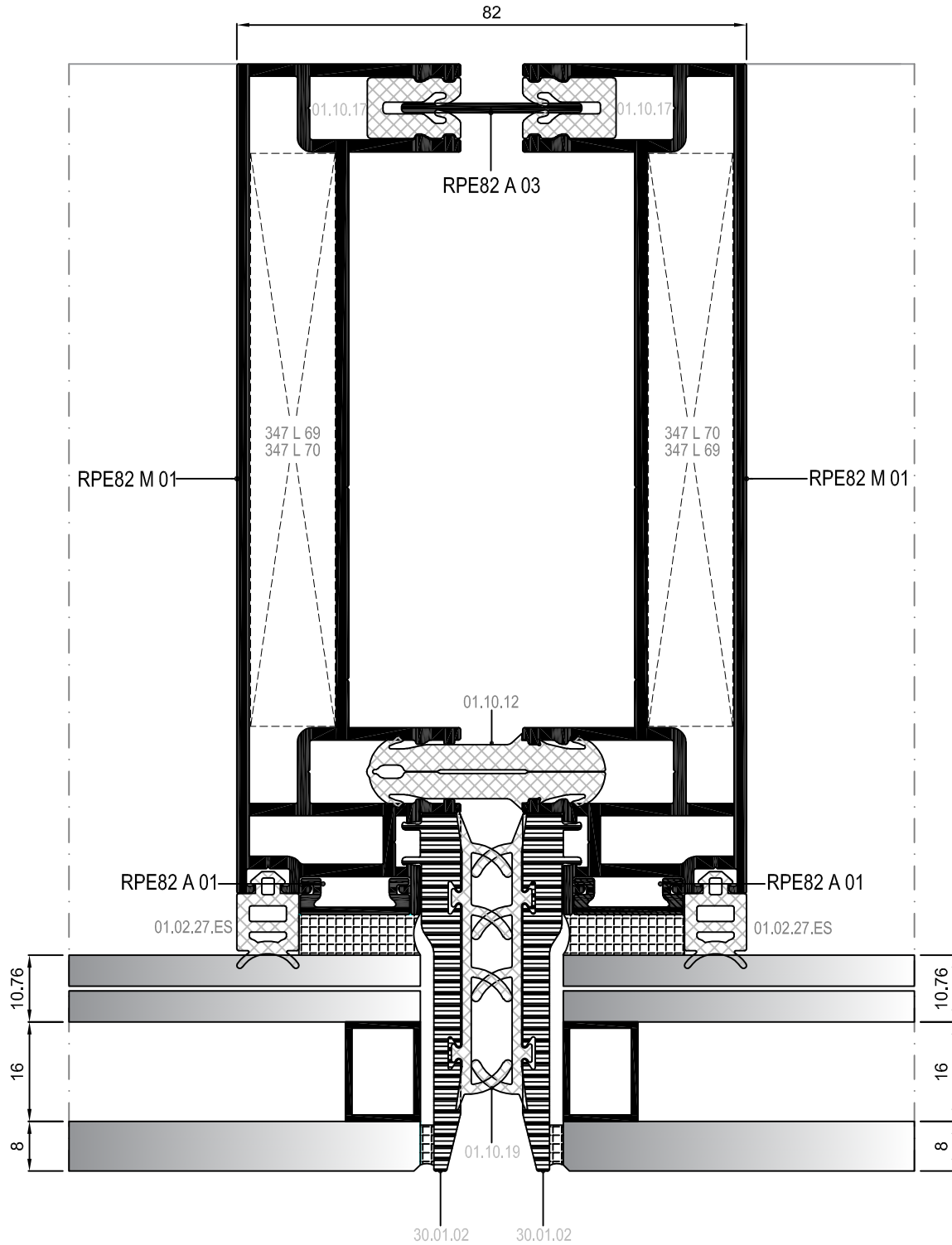

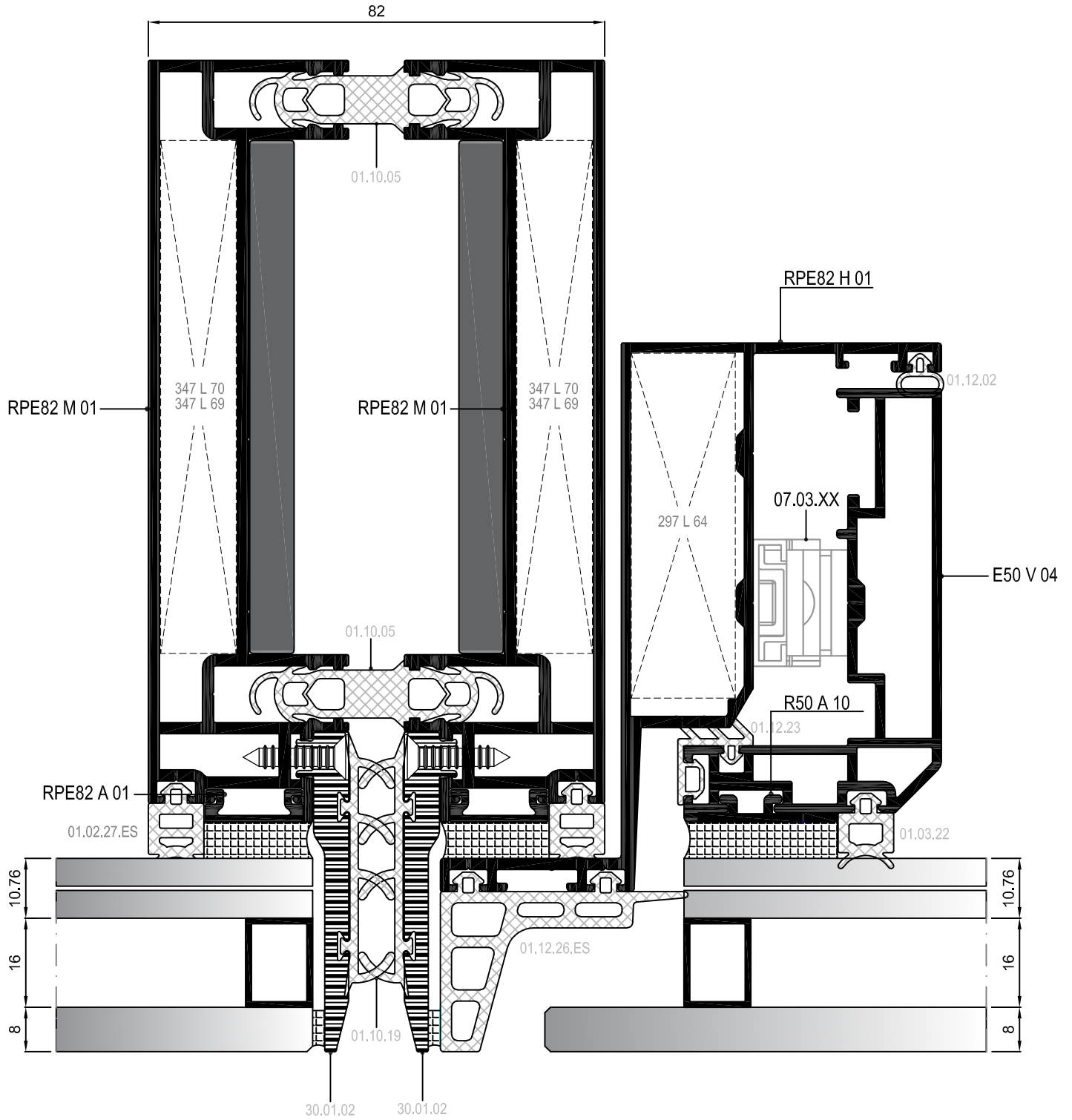

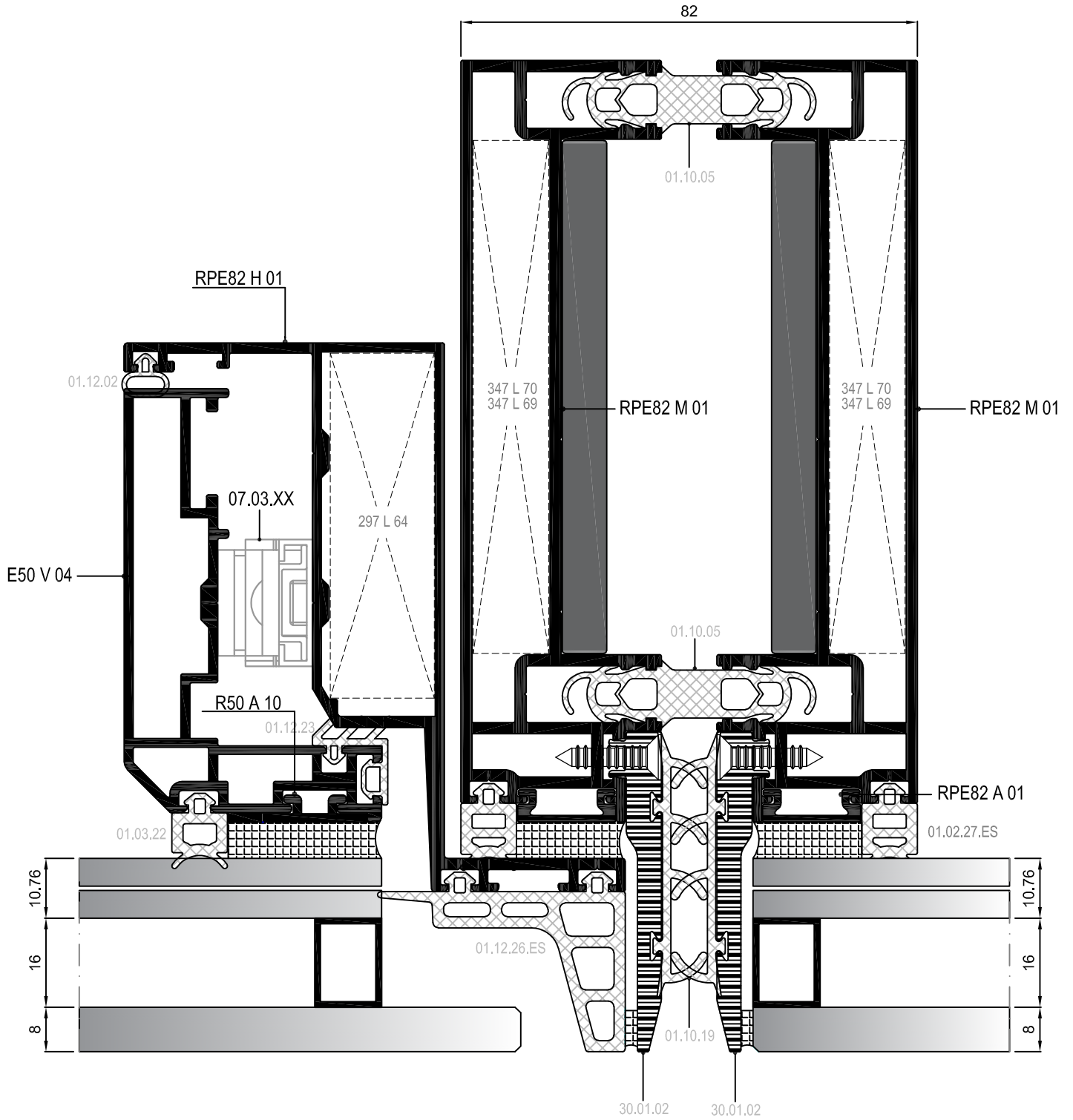

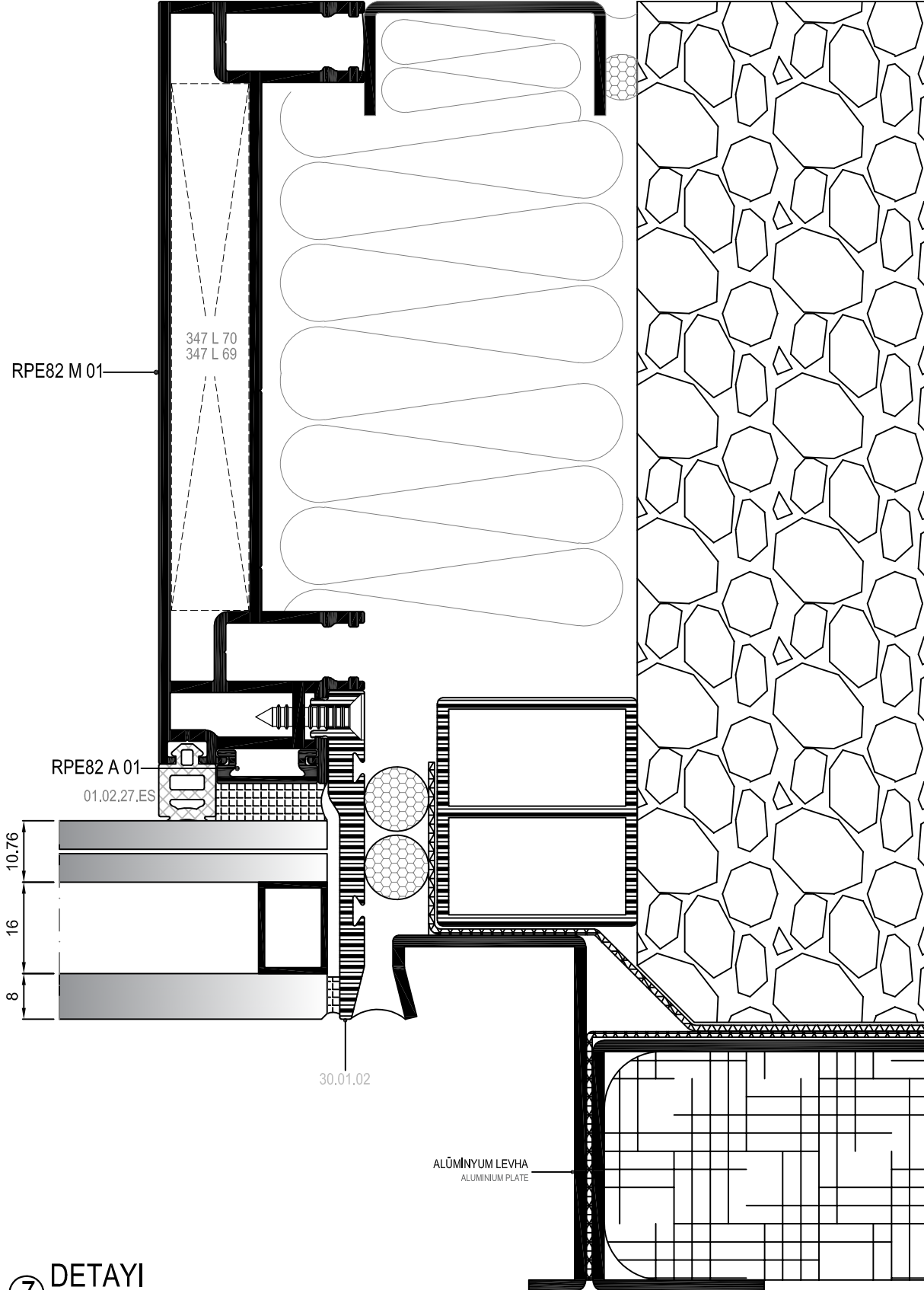

Detay/Detail-8  
Ölçek/Scale 1:2

