

MİMARİ KATALOG
ARCHITECTURAL CATALOGUE

Alüminyum Kapı Pencere ve Giydirme Cephe Sistemleri
Aluminium Window Doors and Facade Systems



AS40

MİMARİ KATALOG ARCHITECTURAL CATALOGUE

Alüminyum Kapı Pencere ve Giydirme Cephe Sistemleri
Aluminium Window Doors and Facade Systems



Rescara Sistem Detayları
Rescara System Details

AS40

PROFİLLER

PROFILES

11

12

13

14

15

16

17

18

19

20

KOD / CODE	AĞIRLIK (kg/m) / WEIGHT	L m	KOD / CODE	AĞIRLIK (kg/m) / WEIGHT	L m
A80T01	1,110	6	A80T02	0,985	6
A80T03	1,108	6			
A60T02	0,769	6			
A60T01	0,830	6			

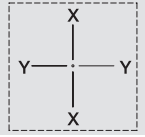

A80T01

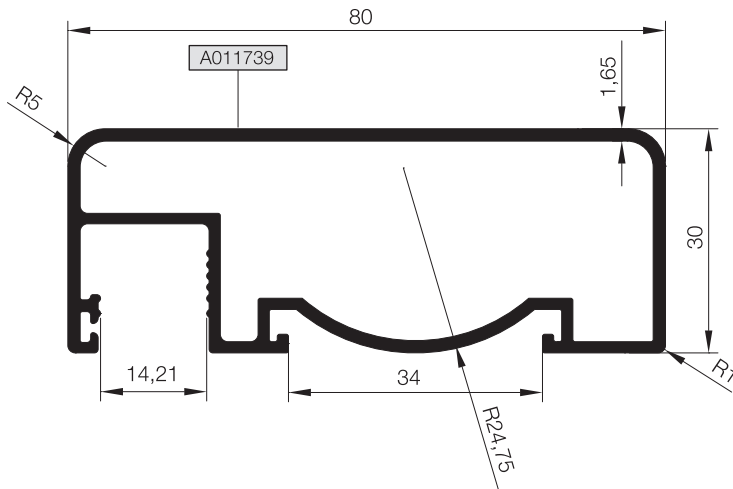

A80T02

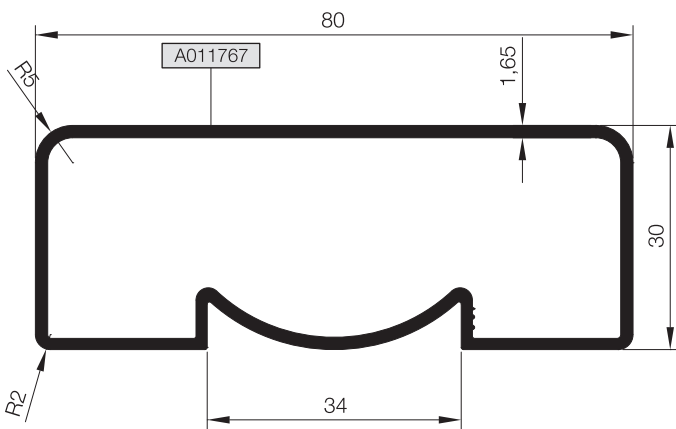

A80T03

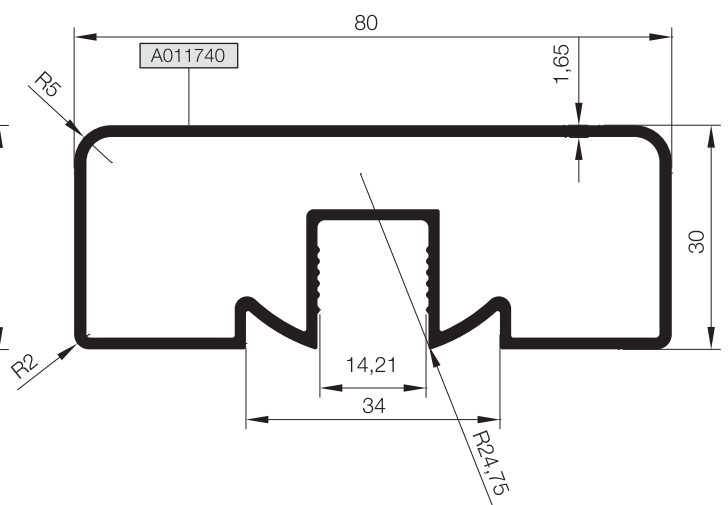

A60T02

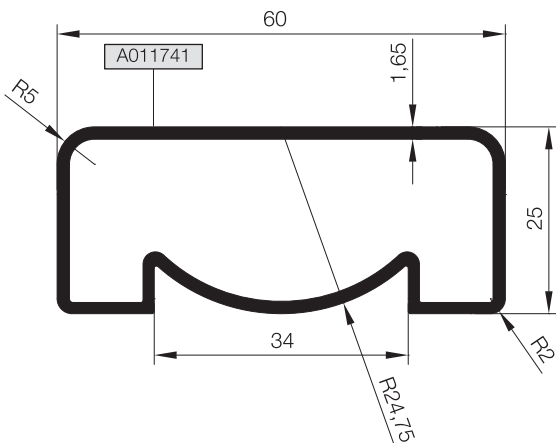

A60T01

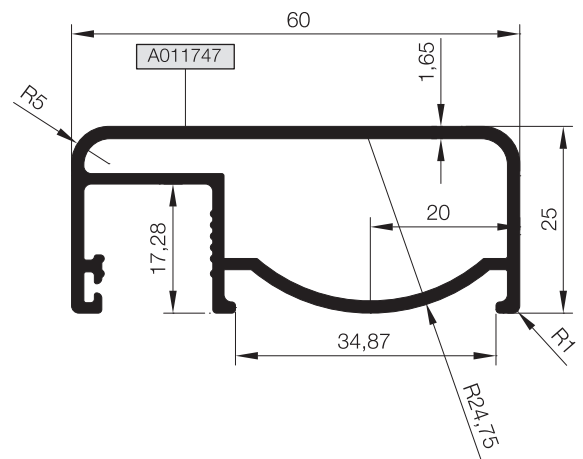

KOD / CODE	AĞIRLIK (kg/m) / WEIGHT	L m	KOD / CODE	AĞIRLIK (kg/m) / WEIGHT	L m
A40C01	1,007	6	A40C08	0,756	6
A40C02	0,941	6	A40C09	0,634	6
A40C03	0,270	6	A40C12	0,684	6
A40C04	0,628	6	A40C13	0,905	6

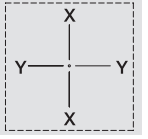

A40C03

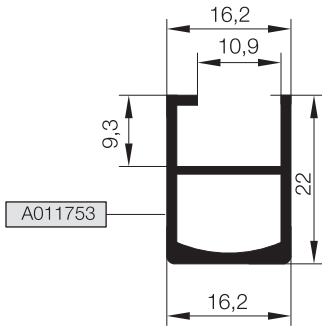

A40C04

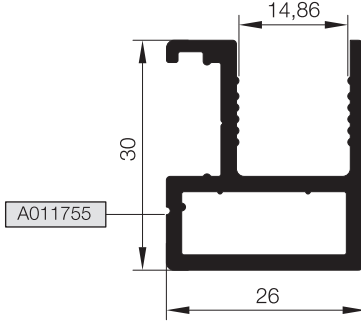

A40C08

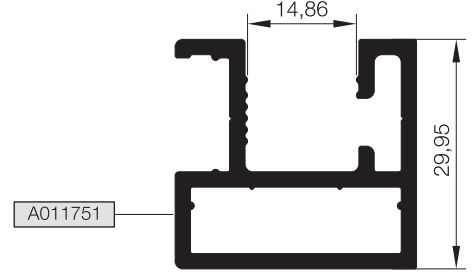

A40C12

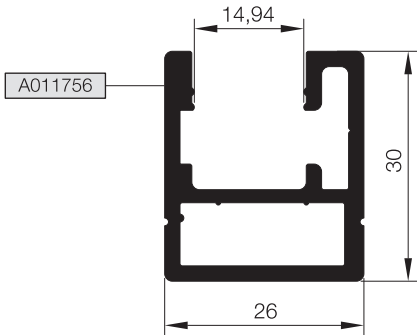

A40C09

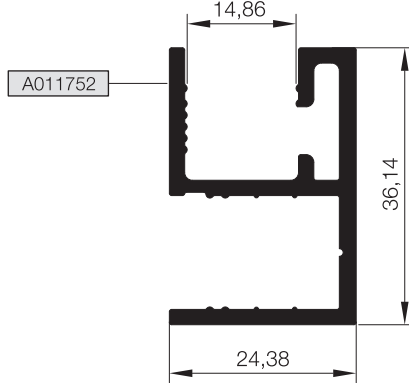

A40C13

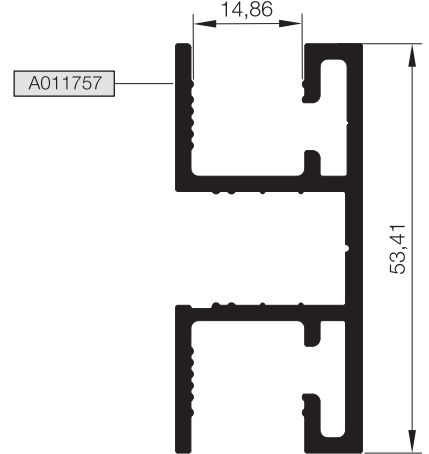

A40C01

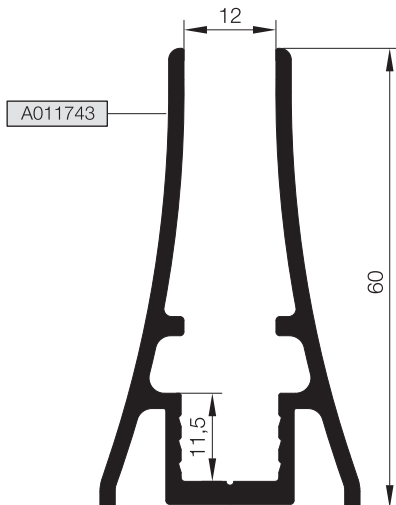

A40C02

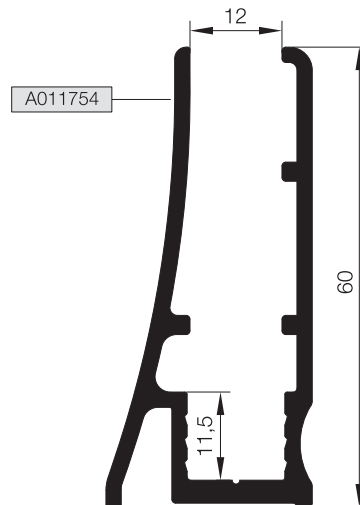

KOD / CODE	AĞIRLIK (kg/m) / WEIGHT	L m	KOD / CODE	AĞIRLIK (kg/m) / WEIGHT	L m
A400D01	0,998	6	A40A01	0,201	6
A400D02	0,960	6	A40A02	0,077	6
A400D04	0,771	6	AS38K04	0,072	6
A400D05	0,722	6			
A400D06	1,802	6			

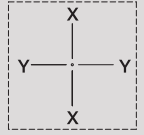

A40A01

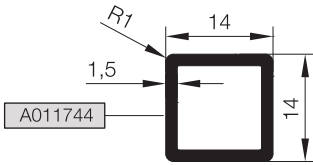

A40A02

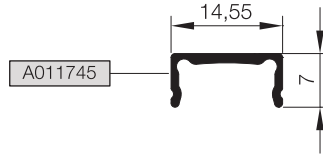

AS38 K 04

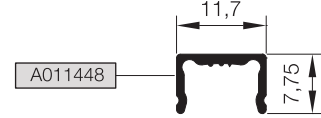

A400 D 01

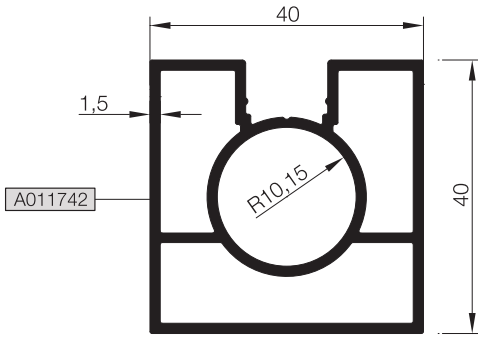

A400 D 02

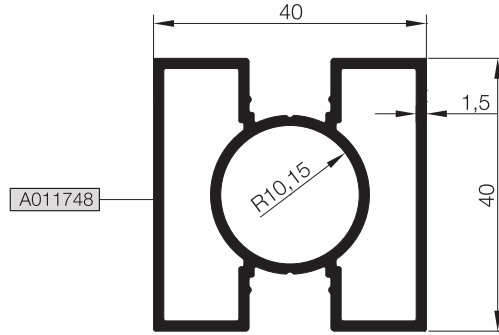

A400 D 05

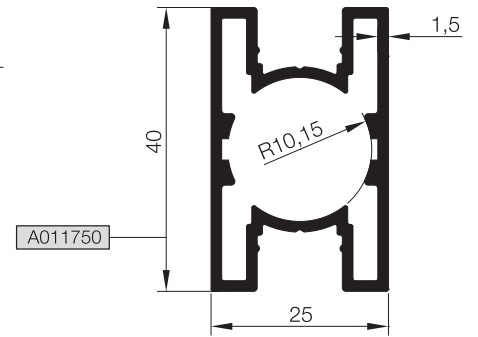

A400 D 04

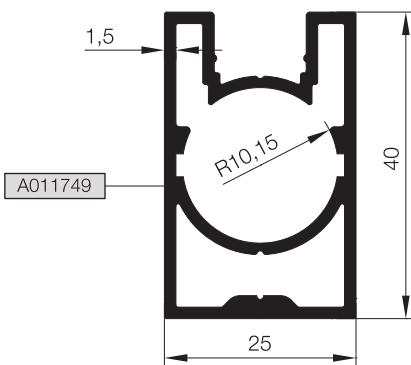

A400 D 06

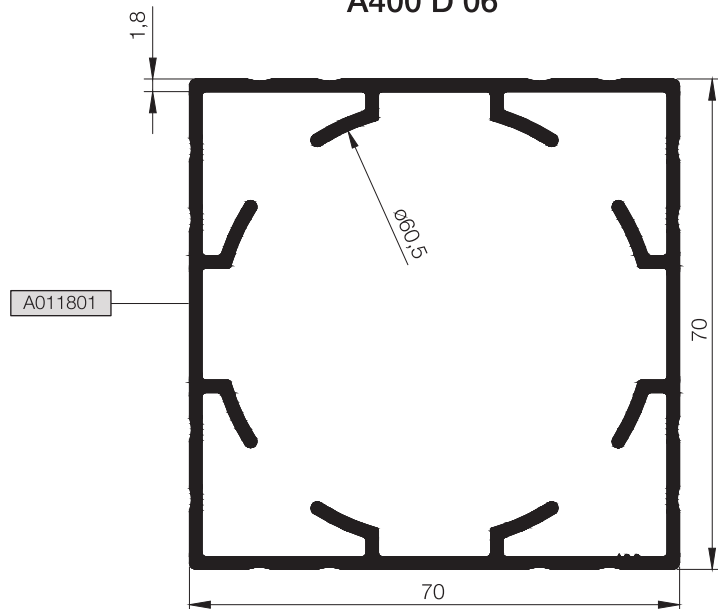

STOKTA BULUNAN SİSTEM PROFİLLERİNİN LİSTESİ (LIST OF SYSTEM PROFILES IN STOCK)

Nr	MIN. SİPARİŞ MİKTARI MIN. ORDER QUANTITY
A011739	75 kg
A011740	75 kg
A011741	75 kg
A011742	75 kg
A011743	75 kg
A011744	75 kg
A011745	75 kg
A011748	75 kg
A011749	75 kg
A011750	75 kg
A011754	75 kg

* STOKTA BULUNMAYAN TÜM PROFİLLER İÇİN MİNİMUM SİPARİŞ MİKTARI 300'KG'DİR.
MINIMUM ORDER QUANTITY FOR ALL THE PROFILES THAT ARE NOT IN STOCK IS 300 KG.

11

12

13

14

15

16

17

18

19

20

MİMARİ KATALOG ARCHITECTURAL CATALOGUE

Alüminyum Kapı Pencere ve Giydirme Cephe Sistemleri
Aluminium Window Doors and Facade Systems



Rescara Sistem Detayları
Rescara System Details

AS40

DETAYLAR

DETAILS

11

12

13

14

15

16

17

18

19

20

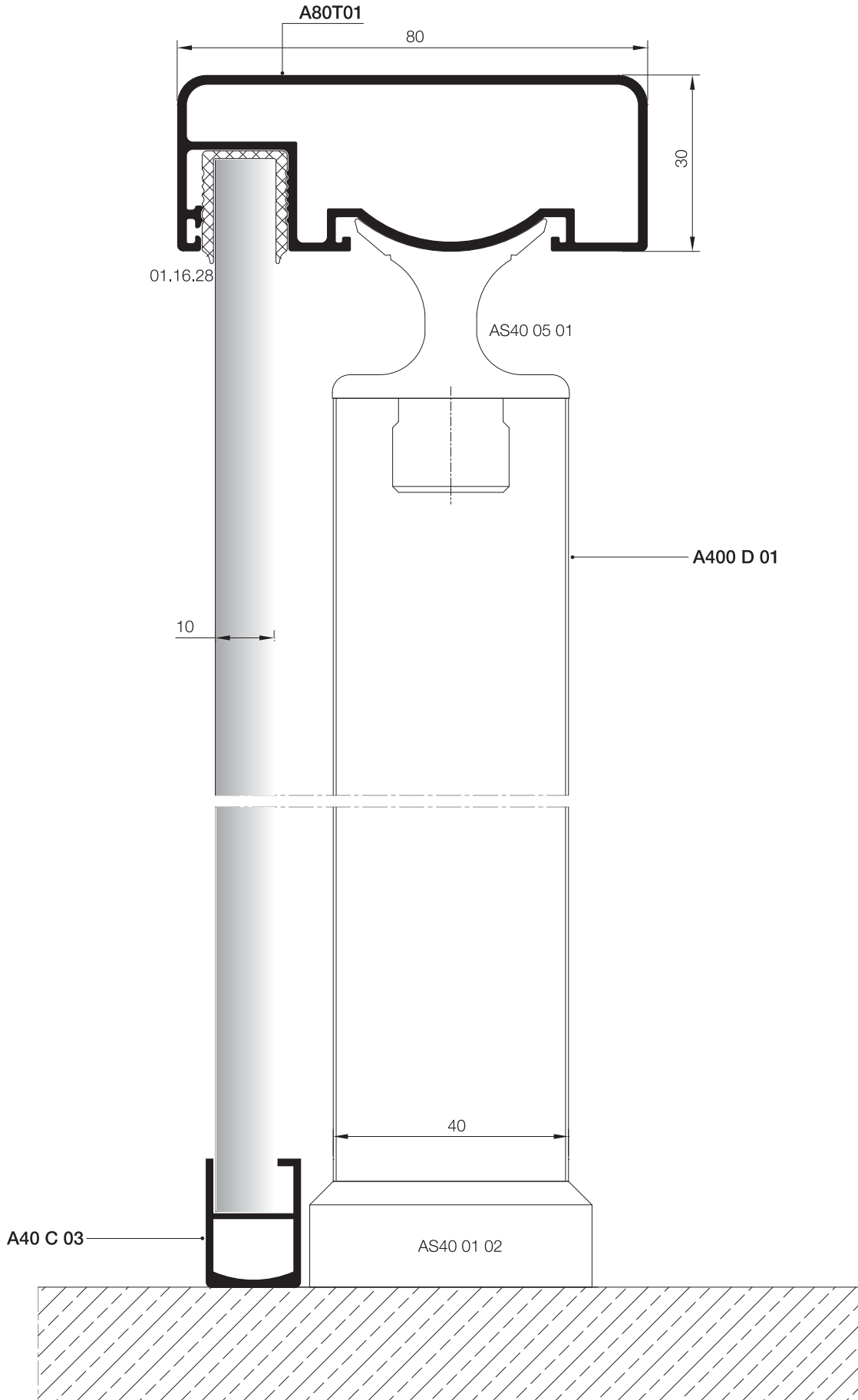

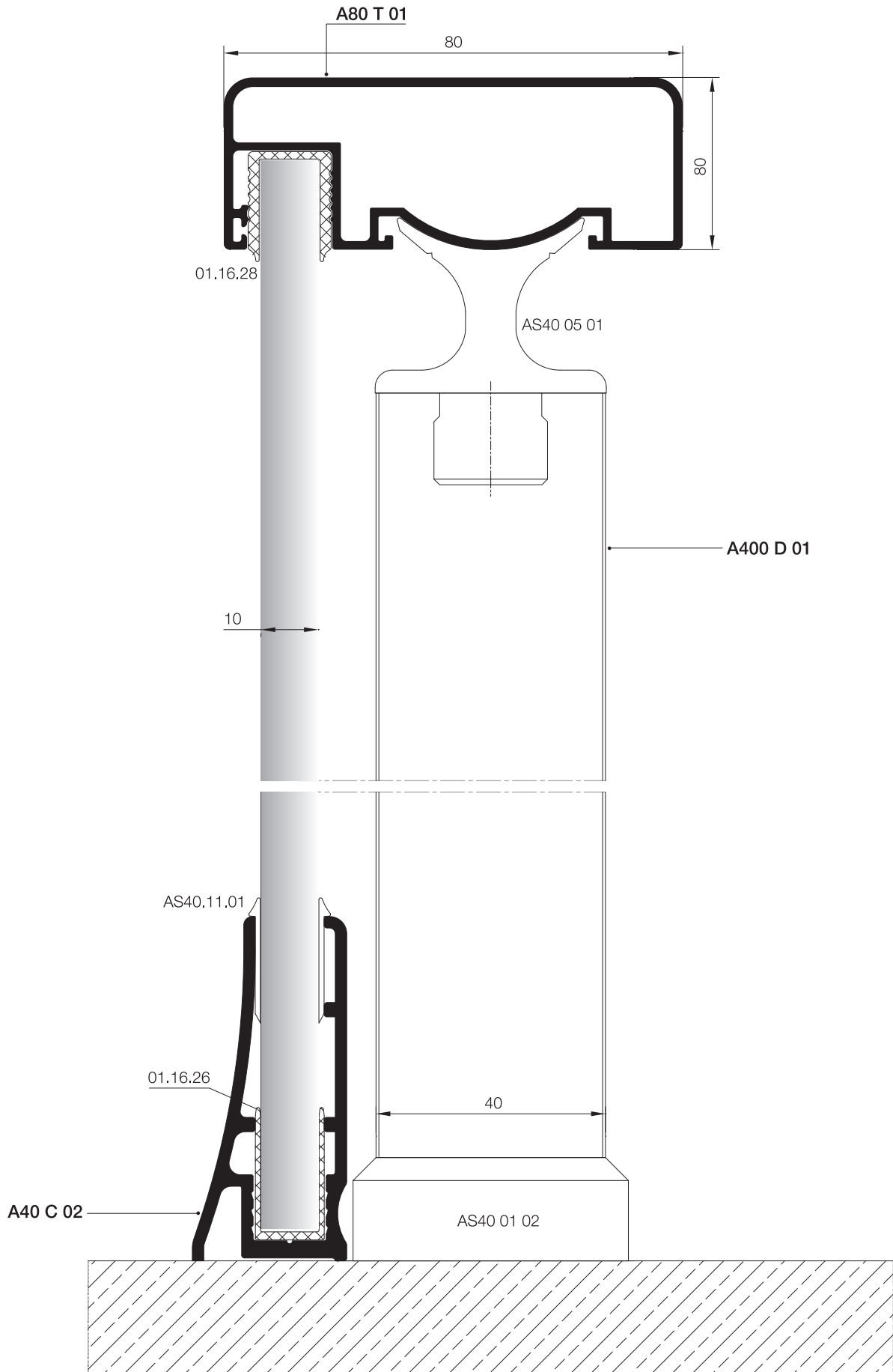

11

12

13

14

15

16

17

18

19

20

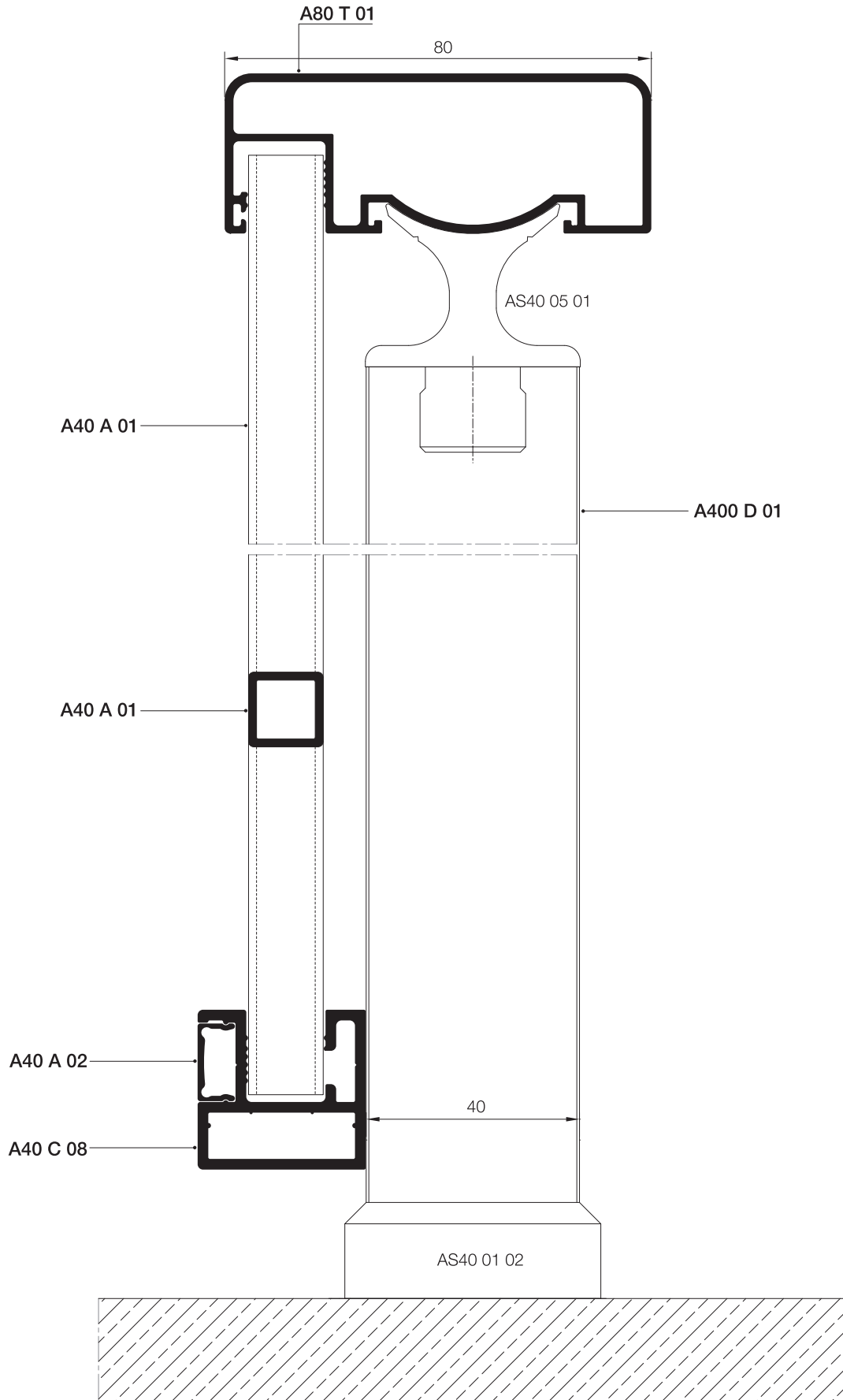

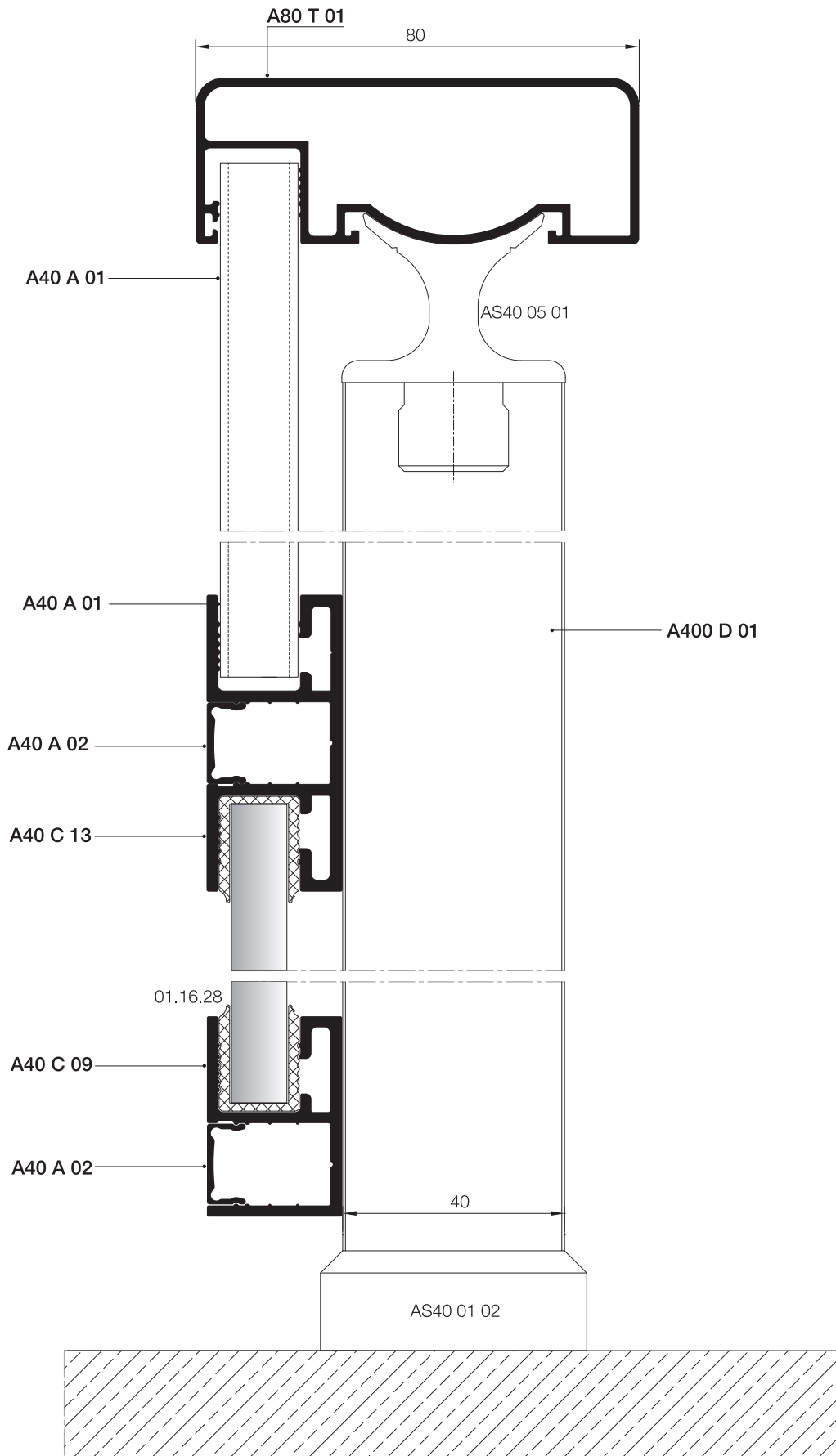

11

12

13

14

15

16

17

18

19

20

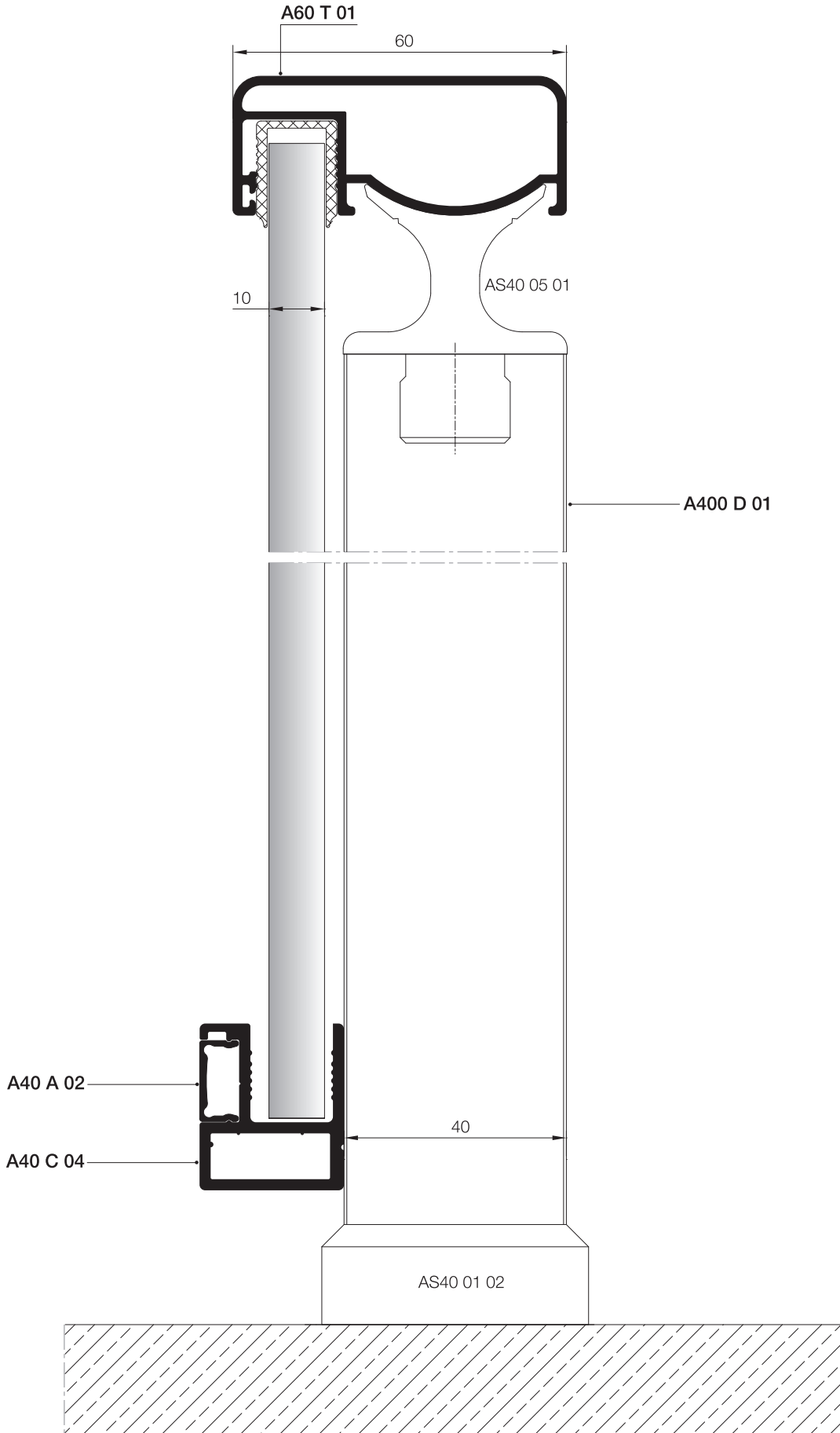

MİMARİ KATALOG ARCHITECTURAL CATALOGUE

Alüminyum Kapı Pencere ve Giydirme Cephe Sistemleri
Aluminium Window Doors and Facade Systems



Rescara Sistem Detayları
Rescara System Details

AS40

AKSESUARLAR

ACCESSORIES

11

12

13

14

15





16

17

18

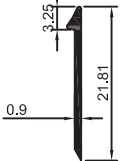
19

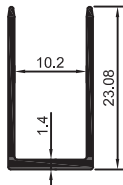
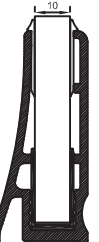
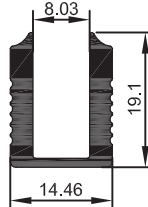
20

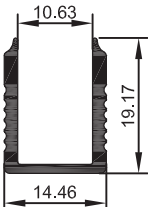
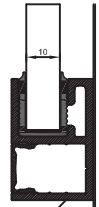
	<p>AS40-11-01 CAM FITİLİ GLAZING GASKET (10mm Cam) Malzeme / Material : PVC</p>				
	<p>01.16.26 CAM FITİLİ GLAZING GASKET (10mm Cam) Malzeme / Material : EPDM Ağırlık / Weight : 65 gr/m Paket / Package : 230,7m/15 kg</p>				
	<p>01.16.27 DIŞ CAM FITİLİ GLAZING GASKET (OUTSIDE) 8mm Cam Malzeme / Material : EPDM Ağırlık / Weight : 165 gr/m Paket / Package : 90,9m/15 kg</p>	 A40C06/			
	<p>01.16.28 CAM FITİLİ GLAZING GASKET (10 mm Cam) Malzeme / Material : EPDM Ağırlık / Weight : 115 gr/m Paket / Package : 130,4m/15 kg</p>	 A40C09/			

11

12

13

14

15

16

17

18

19

20

11		<p>AS40.01.01 40*25 KARE FLANŞ -</p> <p>Malzeme / Material : Alüminyum</p>			<p>AS40.01.08 40*40 KARE DİKME UZUN DEKORLU FLANŞ</p> <p>Malzeme / Material : Alüminyum</p>	
12		<p>AS40.01.02 40*40 KARE DİKME FLANŞ -</p> <p>Malzeme / Material : Alüminyum</p>			<p>AS40.01.09 40*40 KARE DİKME DİK FLANŞ</p> <p>Malzeme / Material : Steel</p>	
13		<p>AS40.01.03 25*60 KARE İKİ DELİKLİ DIŞTAN VİDALI KARE DUVAR FLANŞI</p> <p>Malzeme / Material : Alüminyum</p>			<p>AS40.01.10 70*70 KARE (BABA) DIŞ FLANŞ</p> <p>Malzeme / Material : Steel</p>	
14		<p>AS40.01.04 30*80 KARE İKİ DELİKLİ DIŞTAN VİDALI KARE DUVAR FLANŞI</p> <p>Malzeme / Material : Alüminyum</p>			<p>AS40.01.11 25*60 CAM KANALLI İÇTEN VİDALI (M8) SAPL. KARE DUV. FLANŞ SAĞ</p> <p>Malzeme / Material : Alüminyum</p>	
15		<p>AS40.01.05 30*80 KARE PROFİL HAREKETLİ DUVAR FLANŞI (MENTEŞELİ)</p> <p>Malzeme / Material : Alüminyum</p>			<p>AS40.01.12 30*80 CAM KANALLI İÇTEN VİDALI (M8) SAPL. KARE DUV. FLANŞ SAĞ</p> <p>Malzeme / Material : Alüminyum</p>	
16		<p>AS40.01.06 70*70 KARE (BABA) YER FLANŞI</p> <p>Malzeme / Material : Alüminyum</p>			<p>AS40.01.13 25*60 CAM KANALLI İÇTEN VİDALI (M8) SAPL. KARE DUV. FLANŞ</p> <p>Malzeme / Material : Alüminyum</p>	
17		<p>AS40.01.07 40*40 DEKORLU DİKME FLANŞI</p> <p>Malzeme / Material : Alüminyum</p>			<p>AS40.01.14 30*80 CAM KANALLI İÇTEN VİDALI (M8) SAPL. KARE DUV. FLANŞ</p> <p>Malzeme / Material : Alüminyum</p>	
18						
19						
20						

	<p>AS40.01.15 25*60 CAM KANALLI İÇTEN VİDALI (M8) SAPL. KARE DUV. FLANŞ SOL</p> <p>Malzeme / Material : Alüminyum</p>			<p>AS40.03.03 25*60 KARE PROFİL ÇİFT MENTEŞELİ HAREKETLİ KÖŞE DÖNÜŞ</p> <p>Malzeme / Material : Alüminyum</p>	
	<p>AS40.01.16 30*80 CAM KANALLI İÇTEN VİDALI (M8) SAPL. KARE DUV. FLANŞ SOL</p> <p>Malzeme / Material : Alüminyum</p>			<p>AS40.03.04 25*60 KARE PROFİL HAREKETLİ KÖŞE DÖNÜŞ</p> <p>Malzeme / Material : Alüminyum</p>	
	<p>AS40.01.17 25*60 KARE PROFİL ORT. CAMLI VE DİKM. GÖRE MENTEŞELİ DUV. FLANŞI</p> <p>Malzeme / Material : Alüminyum</p>			<p>AS40.03.05 30*80 KARE PROFİL HAREKETLİ KÖŞE DÖNÜŞ</p> <p>Malzeme / Material : Alüminyum</p>	
	<p>AS40.02.01 30*80 KARE PROFİL ÇİFT YÖNLÜ MENTEŞE</p> <p>Malzeme / Material : Alüminyum</p>			<p>AS40.03.06 14*14 KARE PROFİL EMN. ŞERİDİ HAREKETLİ KÜRE KÖŞE DÖNÜŞ</p> <p>Malzeme / Material : Alüminyum</p>	
	<p>AS40.02.02 25*60 KARE PROFİL ÇİFT YÖNLÜ MENTEŞE</p> <p>Malzeme / Material : Alüminyum</p>			<p>AS40.03.07 14*14 KARE PROFİL ÇOK YÖNLÜ AYARLI KÜRE</p> <p>Malzeme / Material : Alüminyum</p>	
	<p>AS40.03.01 25*60 KARE PROFİL TEK MENTEŞELİ HAREKETLİ KÖŞE DÖNÜŞ</p> <p>Malzeme / Material : Alüminyum</p>			<p>AS40.03.08 25*60 KARE PROFİL ORT. CAMLI VE DİKMEYE GÖRE MAFSALLI KÖŞE DÖNÜŞ</p> <p>Malzeme / Material : Alüminyum</p>	
	<p>AS40.03.02 30*80 KARE PROFİL TEK MENTEŞELİ HAREKETLİ KÖŞE DÖNÜŞ</p> <p>Malzeme / Material : Alüminyum</p>			<p>AS40.03.09 30*80 KARE PROFİL ORT. CAMLI VE DİKMEYE GÖRE MAFSALLI KÖŞE DÖNÜŞ</p> <p>Malzeme / Material : Alüminyum</p>	

11

12

13

14

15

16

17

18

19

20

11		<p>AS40.03.10 30*80 KARE PROFİL ORT. CAMLI VE DİKMEYE GÖRE ÇİFT MENTEŞELİ</p> <p>Malzeme / Material : Alüminyum</p>			<p>AS40.04.03 30*80 KARE PROFİL CAM KANALLI 135° KÖŞE GİZLE.</p> <p>Malzeme / Material : Paslanmaz Sac</p>	
12		<p>AS40.03.11 25*60 KARE PROFİL ORT. CAMLI VE DİKMEYE GÖRE TEK MENTEŞELİ MAFSAL</p> <p>Malzeme / Material : Alüminyum</p>			<p>AS40.04.04 30*80 KARE PROFİL CAM KANALLI 135° KÖŞE GİZLE.</p> <p>Malzeme / Material : Paslanmaz Sac</p>	
13		<p>AS40.03.12 30*80 KARE PROFİL ORT. CAMLI VE DİKMEYE GÖRE TEK MENTEŞELİ MAFSAL</p> <p>Malzeme / Material : Alüminyum</p>			<p>AS40.04.05 (A60 T 02 için) 25*60 KARE PROFİL 90° SABİT KÖŞE TAKOZU</p> <p>Malzeme / Material : Alü. Enjeksiyon</p>	
14		<p>AS40.03.13 25*60 KARE PROFİL ORT. CAMLI VE DİKMEYE GÖRE ÇİFT MENTEŞELİ MAFSAL</p> <p>Malzeme / Material : Alüminyum</p>			<p>AS40.04.06 (A80 T 02 için ve A80 T 03) 30*80 KARE PROFİL 90° SABİT KÖŞE TAKOZU</p> <p>Malzeme / Material : Alü. Enjeksiyon</p>	
15		<p>AS40.03.14 30*80 KARE PROFİL ORT. CAMLI VE DİKMEYE GÖRE ÇİFT MENTEŞELİ KÖŞE</p> <p>Malzeme / Material : Alüminyum</p>			<p>AS40.04.07 (A80 T 01 için) 30*80 KARE PROFİL 90° CAM KANALLI VE SABİT KÖŞE TAKOZU</p> <p>Malzeme / Material : Alü. Enjeksiyon</p>	
16		<p>AS40.04.01 25*60 KARE PROFİL CAM KANALLI 90° KÖŞE GİZLE.</p> <p>Malzeme / Material : Paslanmaz Sac</p>			<p>AS40.04.08 (A60 T 01 için) 25*60 KARE PROFİL 90° CAM KANALLI VE SABİT KÖŞE TAKOZU</p> <p>Malzeme / Material : Alü. Enjeksiyon</p>	
17		<p>AS40.04.02 25*60 KARE PROFİL CAM KANALLI 135° KÖŞE GİZLE.</p> <p>Malzeme / Material : Paslanmaz Sac</p>			<p>AS40.05.01 40*40 KARE SABİT MAFSAL</p> <p>Malzeme / Material : Alüminyum</p>	
18						
19						
20						

	<p>AS40.05.02 40*40 KARE MAFSAL TAKIMI</p> <p>Malzeme / Material : Alüminyum</p>			<p>AS40.07.04 40'LİK KARE DİKME ALINDAN MON. FİTİLLİ CAM TUTUCU TIRNAKLI (TEKLİ)</p> <p>Malzeme / Material : Alüminyum</p>	
	<p>AS40.05.03 40*40 KARE KÜPEŞTE KANALLI MAFSAL TAKIMI</p> <p>Malzeme / Material : Alüminyum</p>			<p>AS40.07.05 40'LİK KARE DİKME CAM TUTUCU TIRNAKLI</p> <p>Malzeme / Material : Alüminyum</p>	
	<p>AS40.06.01 14*14 KARE EMNİYET ŞERİDİ 90° 1.5 mm DİRSEK</p> <p>Malzeme / Material : Paslanmaz</p>			<p>AS40.07.06 40'LİK KARE DİKME CAM TUTUCU</p> <p>Malzeme / Material : Alüminyum</p>	
	<p>AS40.06.02 14*14 KARE EMNİYET ŞERİDİ 135° 1.5 mm DİRSEK</p> <p>Malzeme / Material : Paslanmaz</p>			<p>AS40.07.07 40'LİK KARE DİKME VİDALI CAM TUTUCU (TIRNAKLI)</p> <p>Malzeme / Material : Alüminyum</p>	
	<p>AS40.07.01 40'LİK KARE DİKME CAM</p> <p>Malzeme / Material : Alüminyum</p>			<p>AS40.08.01 14*14 KARE EMNİYET TAPASI</p> <p>Malzeme / Material : Alüminyum</p>	
	<p>AS40.07.02 40'LİK DİKME FİTİLLİ CAM</p> <p>Malzeme / Material : Alüminyum</p>			<p>AS40.08.02 40*40 KARE DİKME TAPASI</p> <p>Malzeme / Material : Alüminyum</p>	
	<p>AS40.07.03 40'LİK KARE DİKME ALINDAN MONTAJ FİTİLLİ CAM TUTUCU</p> <p>Malzeme / Material : Alüminyum</p>			<p>AS40.08.03 40*40 KARE DİKME DEKORLU TAPA</p> <p>Malzeme / Material : Alüminyum</p>	

11

12

13

14

15

16

17

18

19

20

11		<p>AS40.08.04 70*70 KARE PROFİL DEKORLU TAPA</p> <p>Malzeme / Material : Alüminyum</p>			<p>AS40.09.02 40*40 DİKME ALINDAN MONTAJ ÖZEL ARA "U" BAĞLANTI</p> <p>Malzeme / Material : Alüminyum</p>	
12		<p>AS40.08.05 14*14 KARE PROFİL DEKORLU MIZRAK</p> <p>Malzeme / Material : Alüminyum</p>			<p>AS40.09.03 14*14 KARE PROFİL EMNİYET ÇUBUĞU TUTAMAĞI (OVAL)</p> <p>Malzeme / Material : Alüminyum</p>	
13		<p>AS40.08.06 60*25 PROFİL TAPA</p> <p>Malzeme / Material : Alüminyum</p>			<p>AS40.09.04 14*14 KARE PROFİL EMNİYET ÇUBUĞU TUTAMAĞI (KARE)</p> <p>Malzeme / Material : Alüminyum</p>	
14		<p>AS40.08.07 80*30 PROFİL TAPA</p> <p>Malzeme / Material : Alüminyum</p>			<p>AS40.09.05 30*40 LİK DİKME 60'LİK KARE PROFİL AÇILI ARA BAĞLANTI</p> <p>Malzeme / Material : Alüminyum</p>	
15		<p>AS40.08.08 25*40 PROFİL DİKME TAPA</p> <p>Malzeme / Material : Alüminyum</p>			<p>AS40.09.06 40*40 LİK DİKME 80'LİK KARE PROFİL AÇILI ARA BAĞLANTI</p> <p>Malzeme / Material : Alüminyum</p>	
16		<p>AS40.08.09 14*14 KARE PROFİL DEKORLU TAPA</p> <p>Malzeme / Material : Alüminyum</p>			<p>AS40.09.07 40*40 KARE PROFİL DUVAR BAĞLANTI</p> <p>Malzeme / Material : Alüminyum</p>	
17		<p>AS40.09.01 40*40 DİKME 60'LİK KARE PROFİL AÇILI ARA BAĞLANTI</p> <p>Malzeme / Material : Alüminyum</p>			<p>AS40.09.08 40*40 KARE DİKME ALINDAN MONTAJ "T" BAĞLANTI</p> <p>Malzeme / Material : Alüminyum</p>	
18						
19						
20						

	<p>AS40.09.09 60'LIK KARE DUVAR PROFİL AÇILI DUVAR 'L' BAĞLANTI Malzeme / Material : Alüminyum</p>				
	<p>AS40.09.10 80'LIK KARE DUVAR PROFİL AÇILI DUVAR 'L' BAĞLANTI Malzeme / Material : Alüminyum</p>				
	<p>AS40.10.01 30*80 KARE BİLEZİK Malzeme / Material : Paslanmaz Sac</p>				
	<p>AS40.10.02 25*60 KARE BİLEZİK Malzeme / Material : Paslanmaz Sac</p>				
	<p>AS40.10.03 14*14 KARE BİLEZİK Malzeme / Material : Paslanmaz Sac</p>				
	<p>AS-78 EPOKSİ TABANCA EPOXY GUN</p>				

11

12

13

14

15

16

17

18

19

20

