

MİMARİ KATALOG ARCHITECTURAL CATALOGUE

Alüminyum Kapı Pencere ve Giydirme Cephe Sistemleri
Aluminium Window Doors and Facade Systems

RESCARA

RES

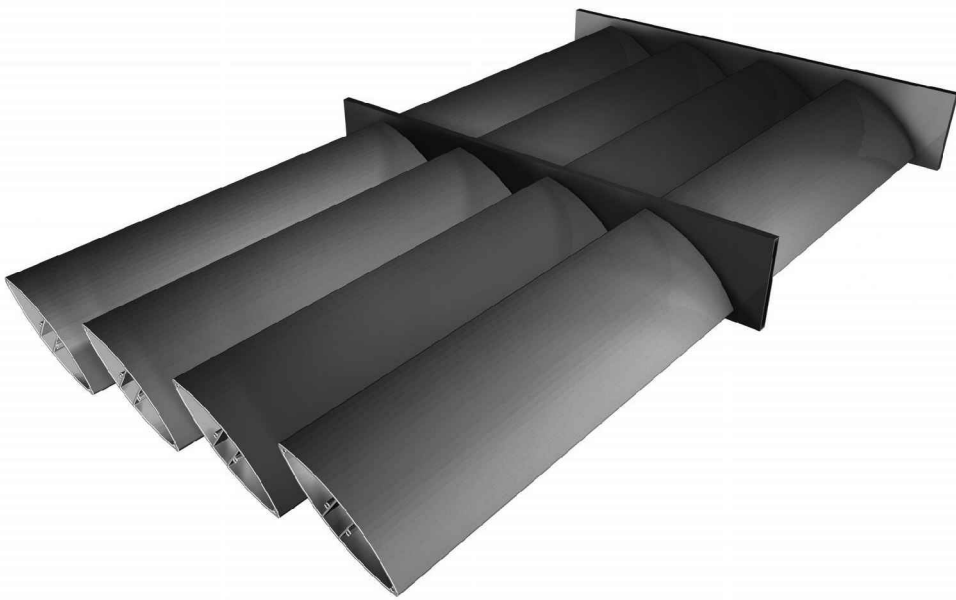

MİMARİ KATALOG

ARCHITECTURAL CATALOGUE

Alüminyum Kapı Pencere ve Giydirme Cephe Sistemleri
Aluminium Window Doors and Facade Systems



Rescara Sistem Detayları
Rescara System Details

RSS

PROFİLLER

PROFILES

01

02

03

04

05

06

07

08

09

10

KOD / CODE	AĞIRLIK (kg/m) / WEIGHT	L m	KOD / CODE	AĞIRLIK (kg/m) / WEIGHT	L m
SOLAR P 03	0,944	6	SOLAR P 02	2,925	6
SOLAR P 17	1,057	6	SOLAR P 16	4,406	6
SOLAR P 19	1,529	6	SOLAR P 34	2,626	6

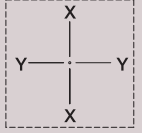

SOLAR P 03

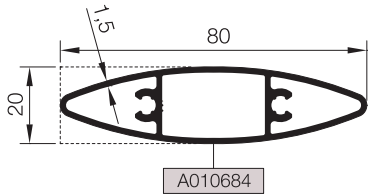

SOLAR P 17

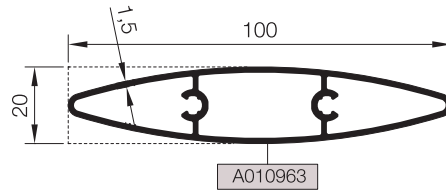

SOLAR P 19

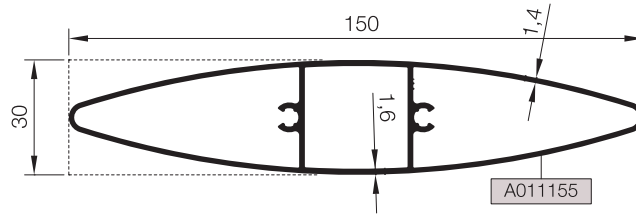

SOLAR P 34

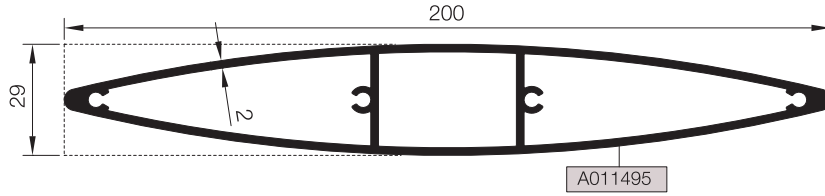

SOLAR P 02

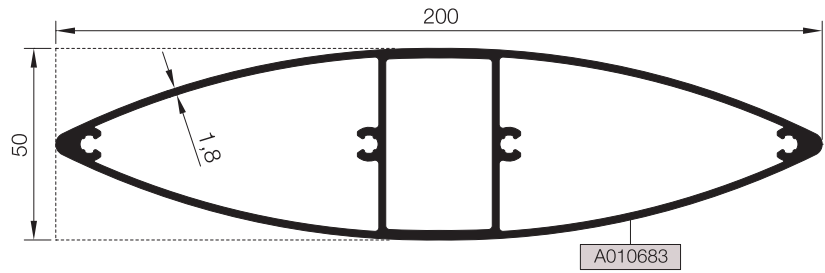

SOLAR P 16

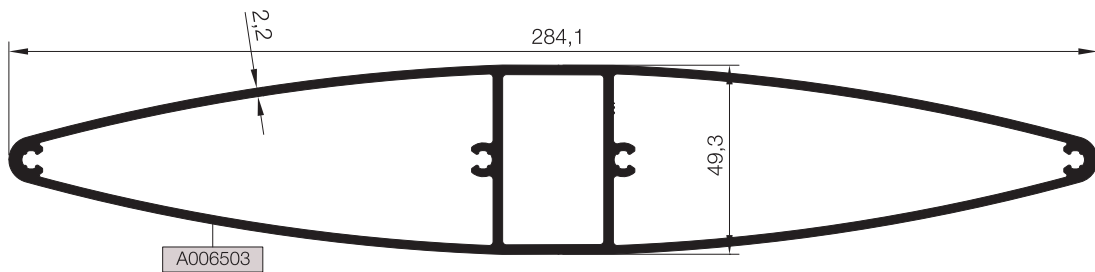

Ölçek/Scale: 1/2

KOD / CODE	AĞIRLIK (kg/m) / WEIGHT	L m	KOD / CODE	AĞIRLIK (kg/m) / WEIGHT	L m
SOLAR P 24	4,182	6	SOLAR P 27	6,677	6
1148	0,980	6	SOLAR P 32	3,905	6
1147	1,817	6			

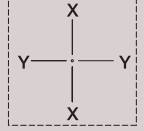

SOLAR P 24

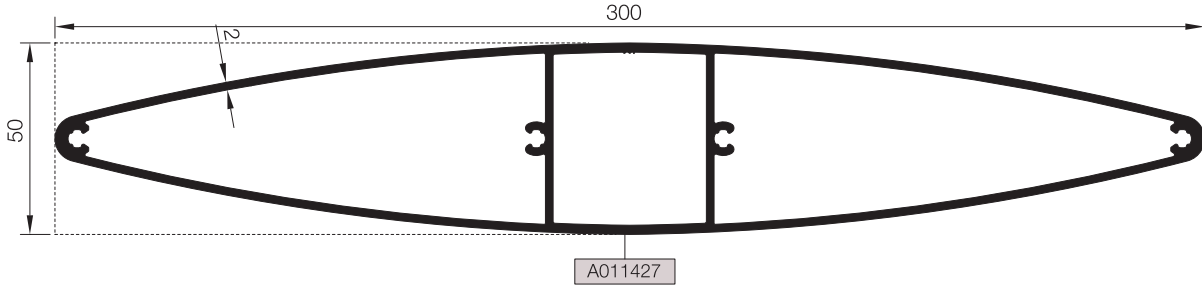

SOLAR P 32

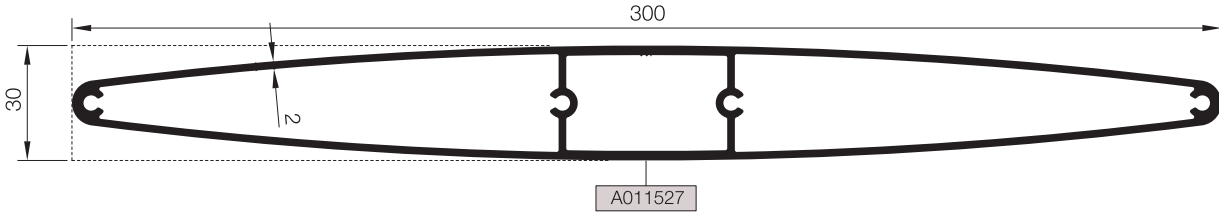

SOLAR P 27

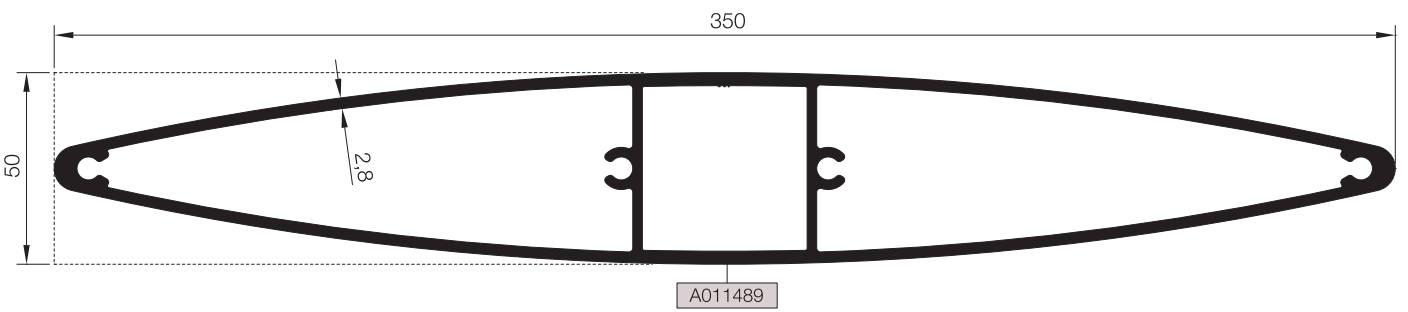

A001148

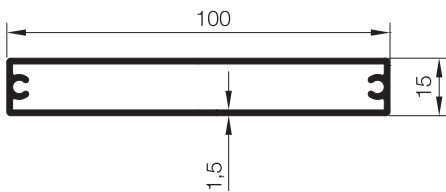

A001147

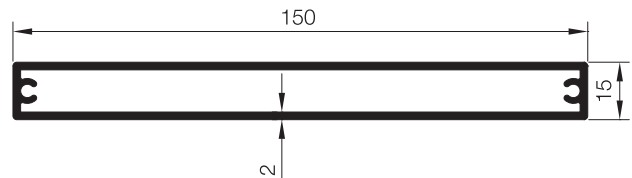

Ölçek/Scale: 1/2

KOD / CODE	AĞIRLIK (kg/m) / WEIGHT	L m
SOLAR P 20	9,677	6
SOLAR P 21	7,033	6

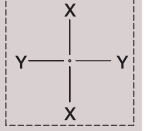

SOLAR P 20

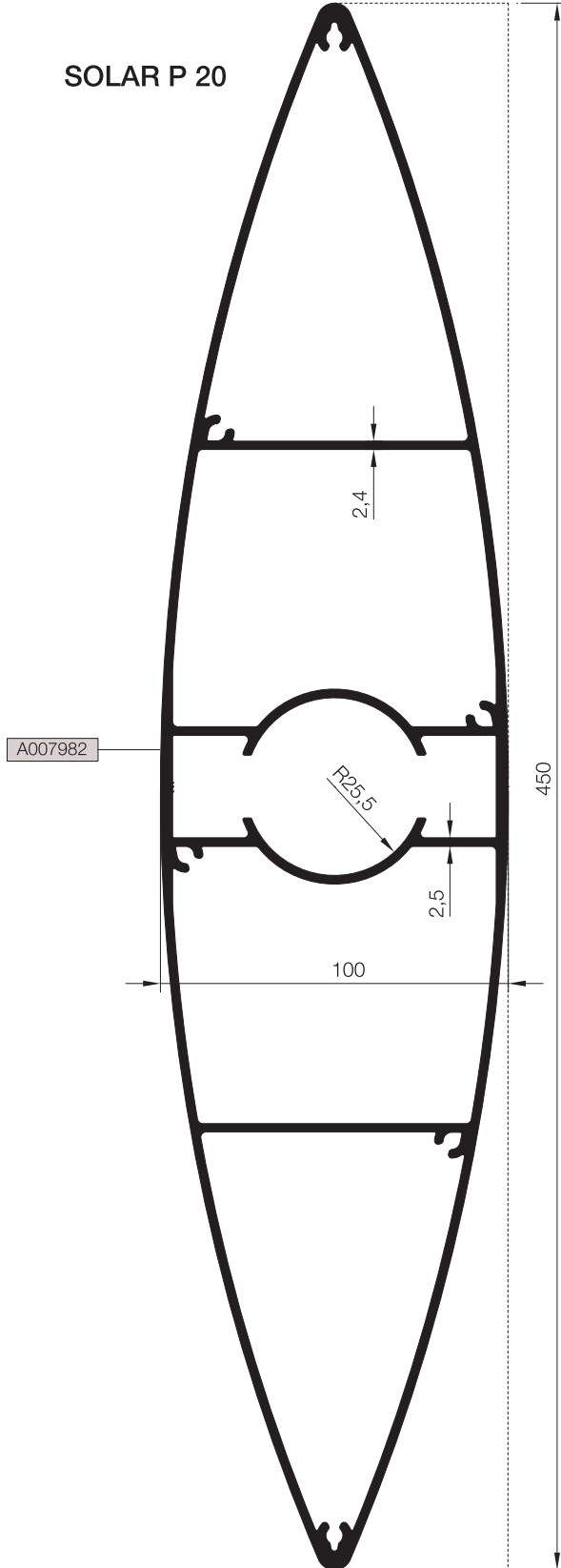

SOLAR P 21

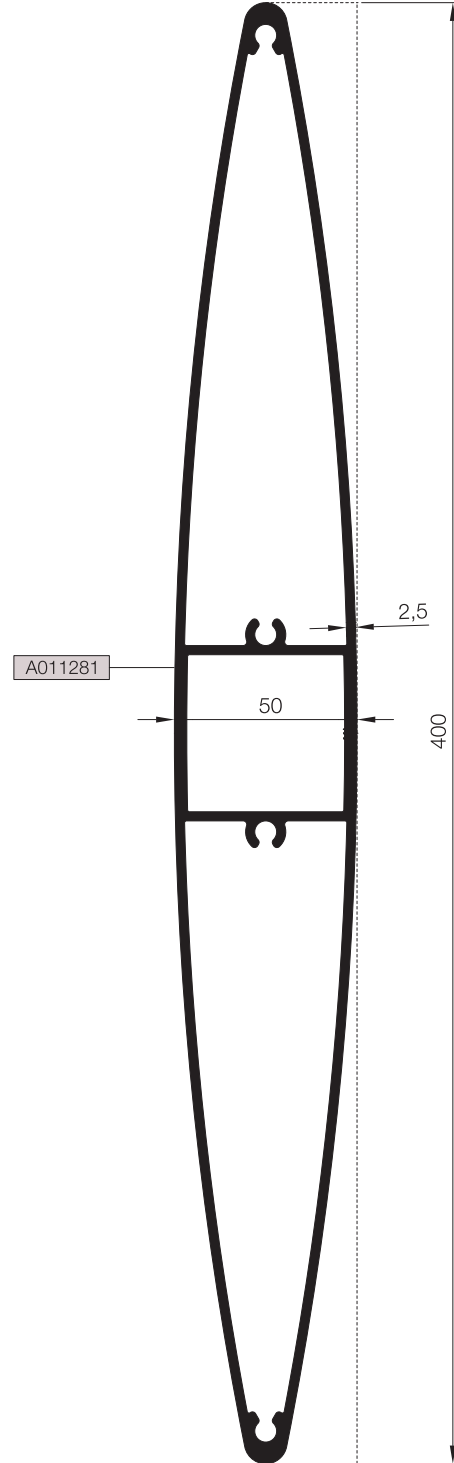

Ölçek/Scale: 1/2

KOD / CODE	AĞIRLIK (kg/m) / WEIGHT	L m	KOD / CODE	AĞIRLIK (kg/m) / WEIGHT	L m
SOLAR P 22	2,305	6	SOLAR P 13	1,785	6
SOLAR P 26	1,679	6	SOLAR P 14	1,570	6

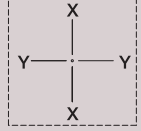

SOLAR P 22

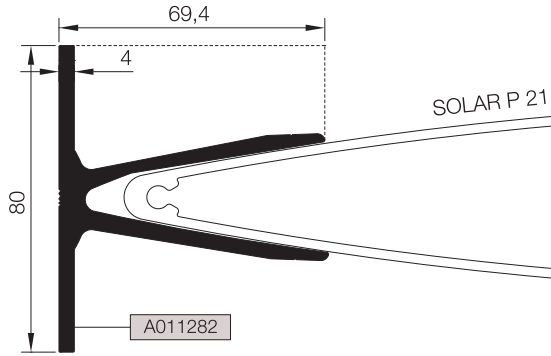

SOLAR P 21 İÇİN / FOR SOLAR P 21

SOLAR P 26

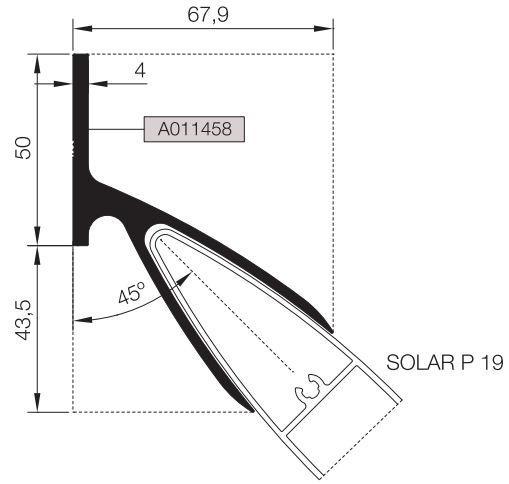

SOLAR P 19 İÇİN / FOR SOLAR P 19

SOLAR P 13

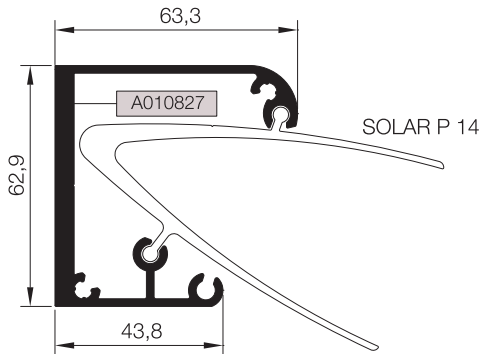

SOLAR P 14 İÇİN / FOR SOLAR P 14

SOLAR P 14

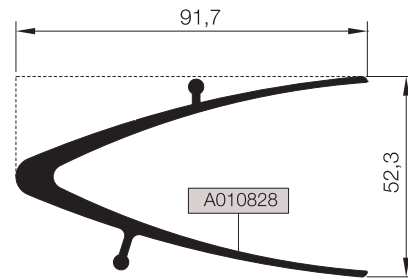

SOLAR P 02 İÇİN / FOR SOLAR P 02

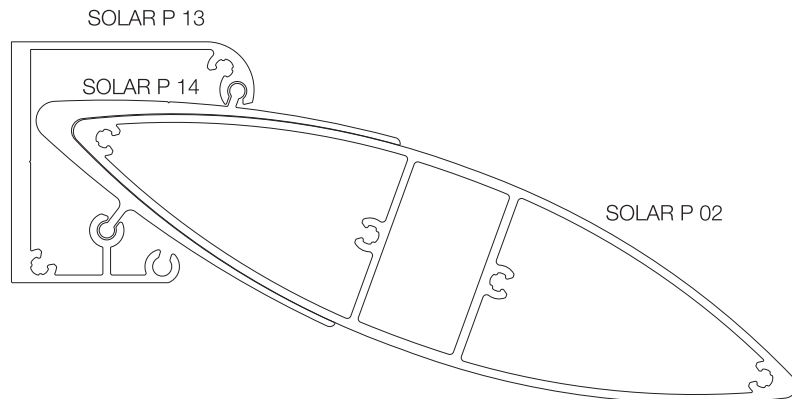

Ölçek/Scale: 1/2

KOD / CODE	AĞIRLIK (kg/m) / WEIGHT	L m	KOD / CODE	AĞIRLIK (kg/m) / WEIGHT	L m
SOLAR P 28	1,582	6	SOLAR P 31	2,411	6
SOLAR P 29	2,385	6	SOLAR P 33	1,672	6
SOLAR P 30	2,192	6			

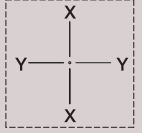

SOLAR P 28

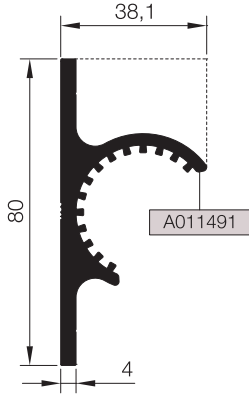

SOLAR P 29

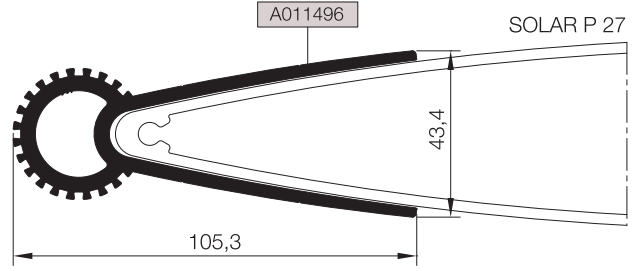

SOLAR P 27 İÇİN / FOR SOLAR P 27

SOLAR P 30

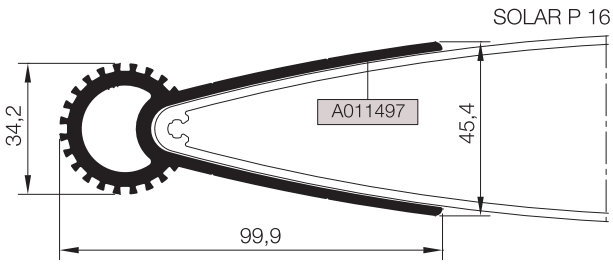

SOLAR P 16 İÇİN / FOR SOLAR P 16

SOLAR P 31

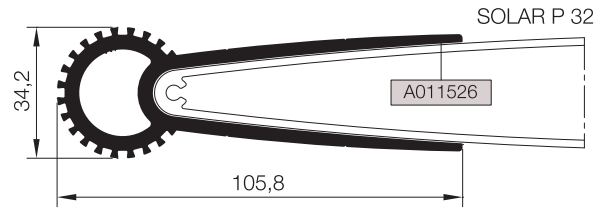

SOLAR P 32 İÇİN / FOR SOLAR P 32

SOLAR P 33

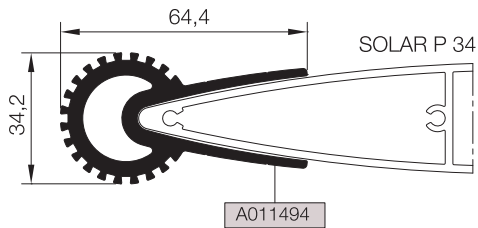

SOLAR P 34 İÇİN / FOR SOLAR P 34

Ölçek/Scale: 1/2

KOD / CODE	AĞIRLIK (kg/m) / WEIGHT	L m	KOD / CODE	AĞIRLIK (kg/m) / WEIGHT	L m
SOLAR P 35	0,541	6	SOLAR P 38	2,757	6
SOLAR P 36	0,967	6	SOLAR P 39	0,193	6
SOLAR P 37	1,466	6			

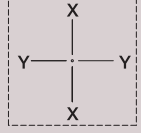

SOLAR P 35

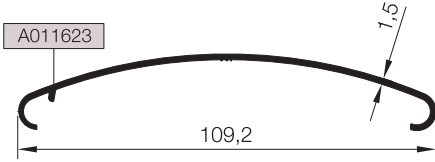

SOLAR P 38 İÇİN / FOR SOLAR P 38

SOLAR P 36

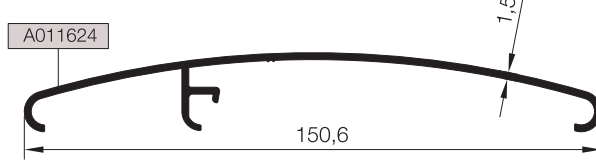

SOLAR P 38 İÇİN / FOR SOLAR P 38

SOLAR P 37

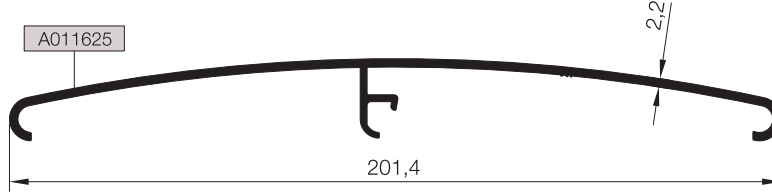

SOLAR P 38 İÇİN / FOR SOLAR P 38

SOLAR P 38

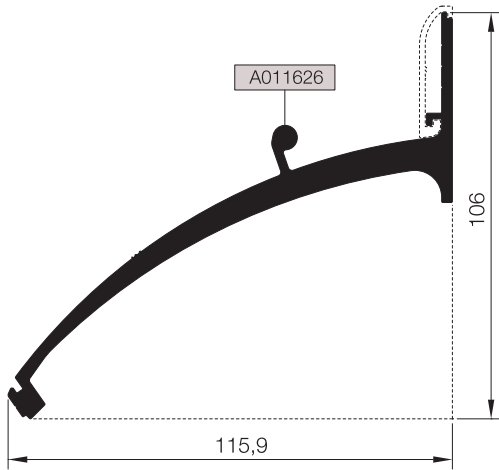

SOLAR P 39

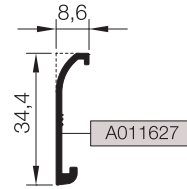

SOLAR P 38 İÇİN / FOR SOLAR P 38

Ölçek/Scale: 1/2

STOKTA BULUNAN SİSTEM PROFİLLERİNİN LİSTESİ (LIST OF SYSTEM PROFILES IN STOCK)

Nr	MIN. SİPARİŞ MİKTARI MIN. ORDER QUANTITY
A001147	75 kg
SOLAR P 17 A010963	75 kg

* STOKTA BULUNMAYAN TÜM PROFİLLER İÇİN MİNİMUM SİPARİŞ MİKTARI 300*KG'DİR.
MINIMUM ORDER QUANTITY FOR ALL THE PROFILES THAT ARE NOT IN STOCK IS 300 KG.

MİMARİ KATALOG

ARCHITECTURAL CATALOGUE

Alüminyum Kapı Pencere ve Giydirme Cephe Sistemleri
Aluminium Window Doors and Facade Systems



Rescara Sistem Detayları
Rescara System Details

RSS

DETAYLAR

DETAILS

01

02

03

04

05

06

07

08

09

10

SOLAR P 02, SOLAR P 13, SOLAR P 14 İLE DETAY
DETAIL WITH SOLAR P 02, SOLAR P 13, SOLAR P 14

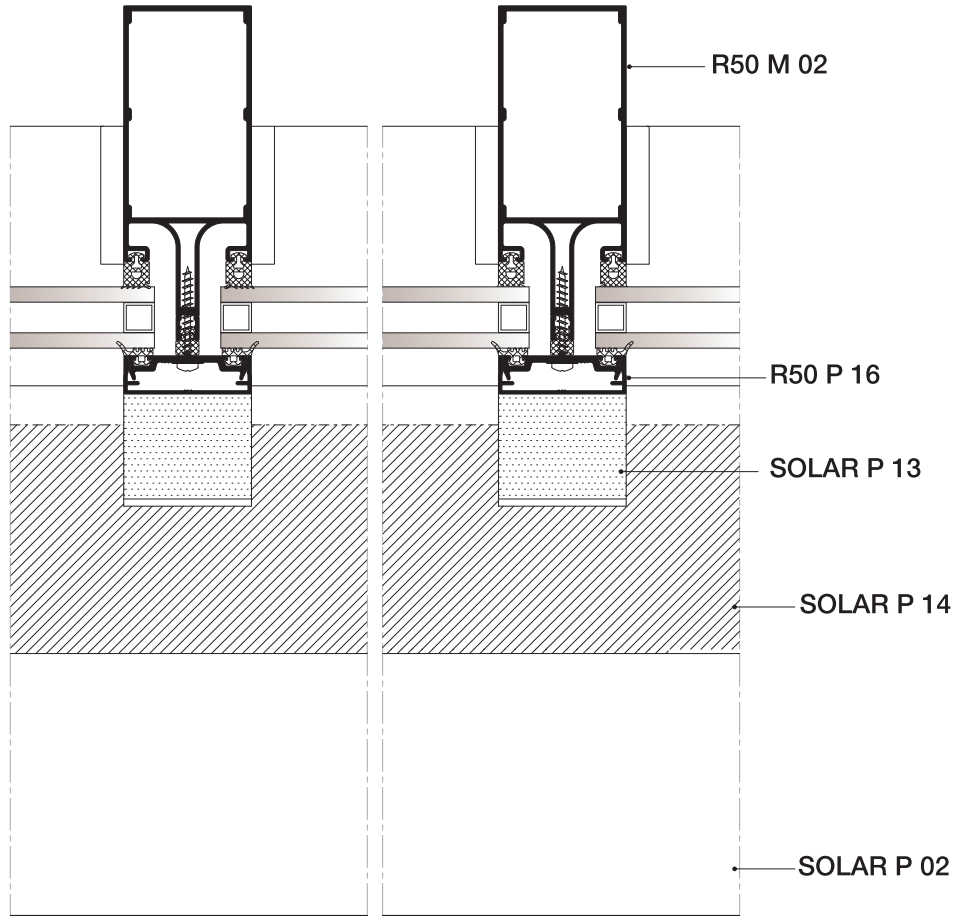

PLAN
PLAN

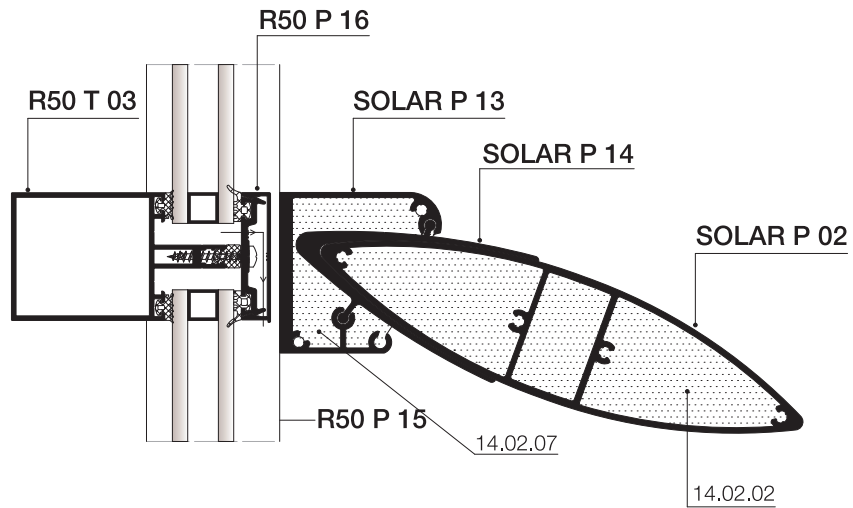

KESİT
SECTION

Ölçek/Scale: 1/3

SOLAR P 28, SOLAR P 31, SOLAR P 32 İLE DETAY
DETAIL WITH SOLAR P 28, SOLAR P 31, SOLAR P 32

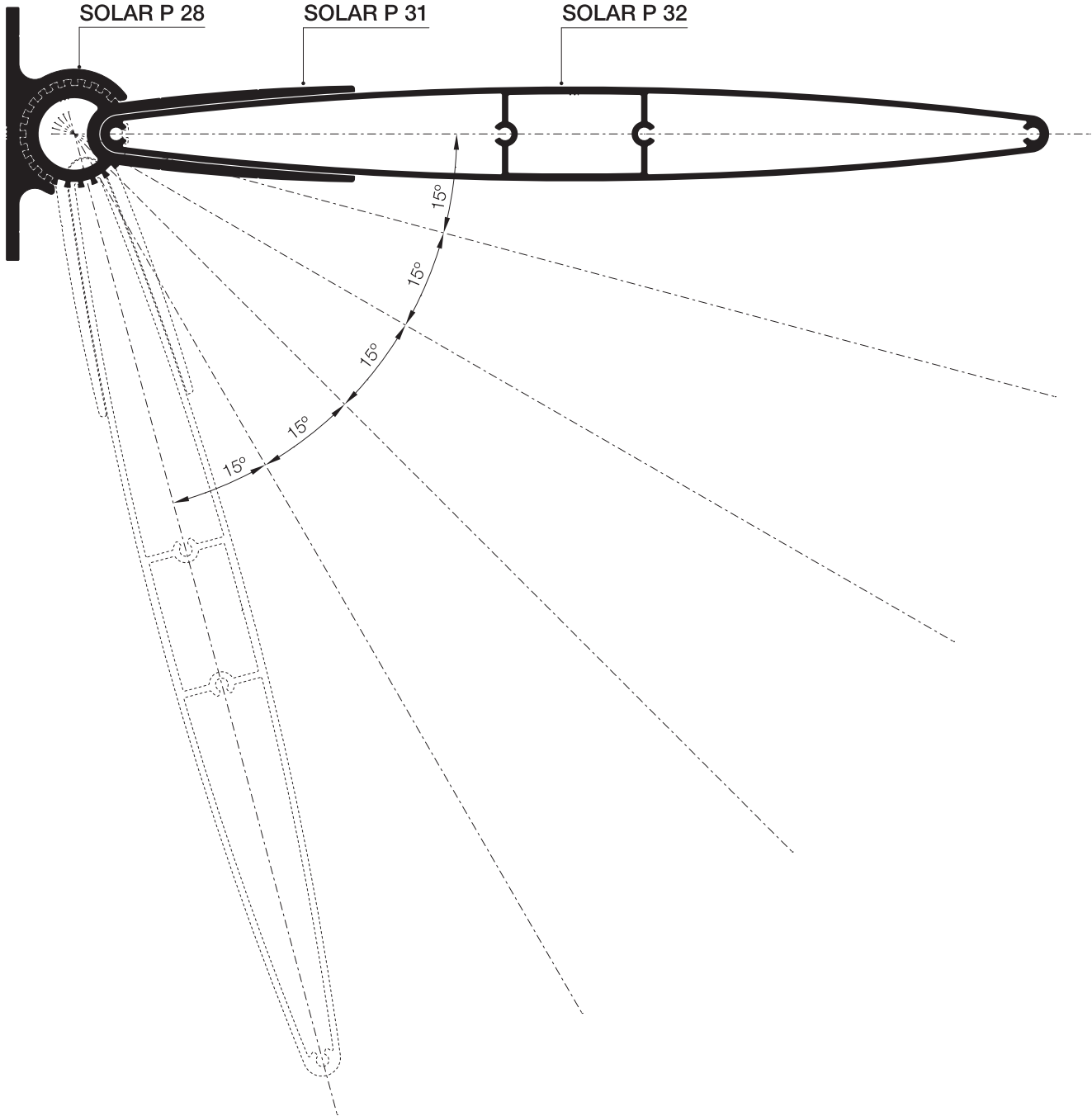

01

02

03

04

05

06

07

08

09

10

Ölçek/Scale: 1/2

SOLAR P 35-36-37, SOLAR P 38, SOLAR P 39 İLE DETAY
DETAIL WITH SOLAR P 35-36-37, SOLAR P 31, SOLAR P 32

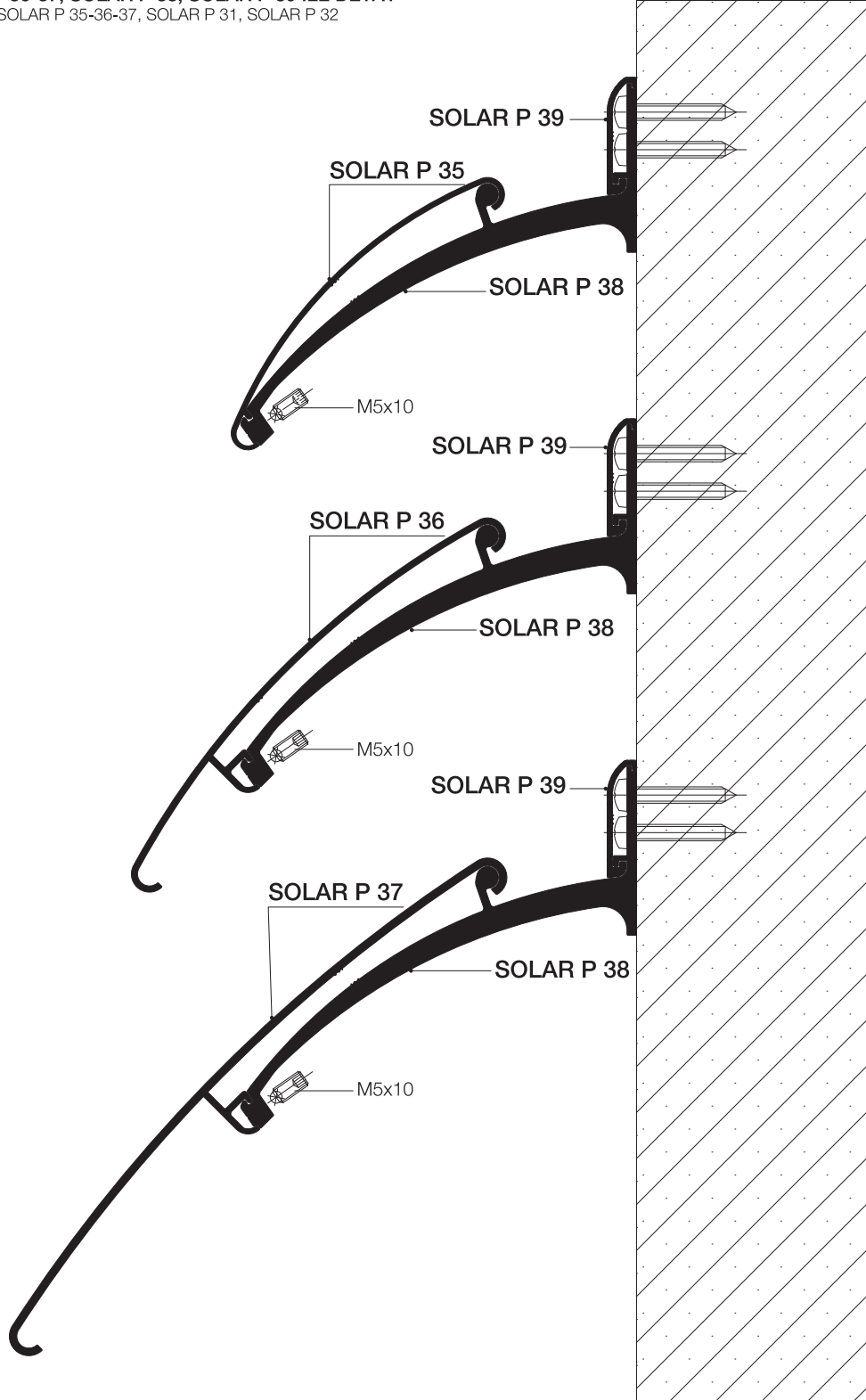

Ölçek/Scale: 1/2

MİMARİ KATALOG

ARCHITECTURAL CATALOGUE

Alüminyum Kapı Pencere ve Giydirme Cephe Sistemleri
Aluminium Window Doors and Facade Systems



Rescara Sistem Detayları
Rescara System Details

RSS

AKSESUARLAR

ACCESSORIES

01

02

03

04

05











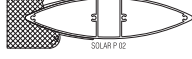

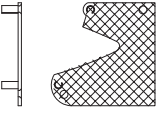



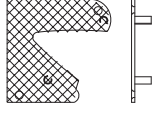
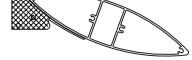

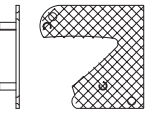
06

07

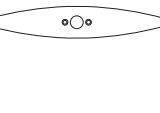
08

09

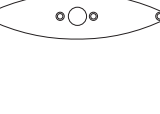
10

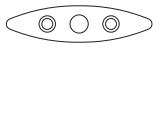
01		14.02.05 YAN KAPAK SOL CAP-LEFT Malzeme / Material : PVC			14.02.09 YAN KAPAK CAP Malzeme / Material : Alüminyum	
02		14.02.06 YAN KAPAK SAĞ CAP-RIGHT Malzeme / Material : PVC			14.02.10 YAN KAPAK CAP Malzeme / Material : Alüminyum	
03		14.02.07 YAN KAPAK SOL CAP-LEFT Malzeme / Material : PVC			14.02.11 YAN KAPAK CAP Malzeme / Material : Alüminyum	
04		14.02.08 YAN KAPAK SAĞ CAP-RIGHT Malzeme / Material : PVC			14.02.12 YAN KAPAK CAP Malzeme / Material : Alüminyum	
05		14.02.01 YAN KAPAK CAP Malzeme / Material : Alüminyum			14.02.13 YAN KAPAK CAP Malzeme / Material : Alüminyum	
06		14.02.02 YAN KAPAK CAP Malzeme / Material : Alüminyum				
07		14.02.03 YAN KAPAK CAP Malzeme / Material : Alüminyum	